

Teiknið þær myndir sem vantar og dekkið stytta fleti.

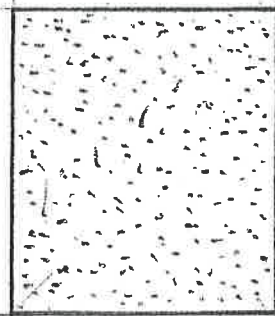

O

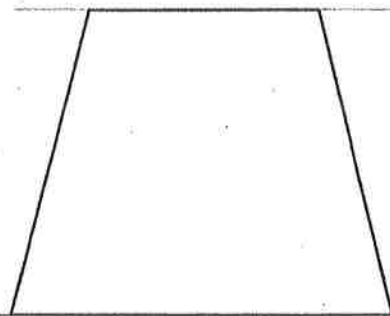
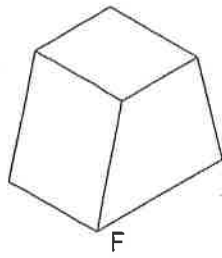
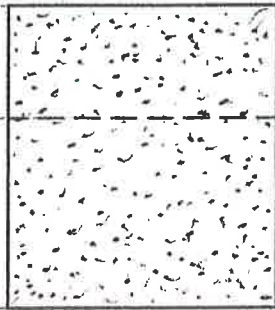
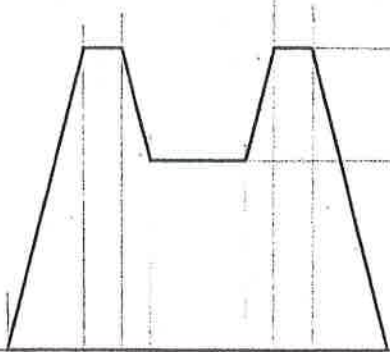
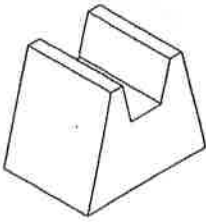
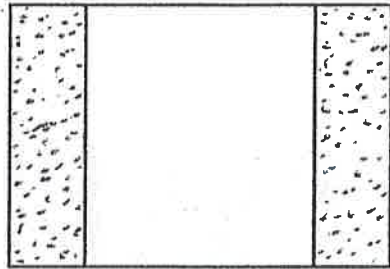

F

O

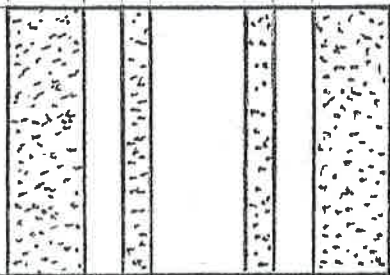

Teiknið þær myndir sem vantar og dekkið stytta fleti.

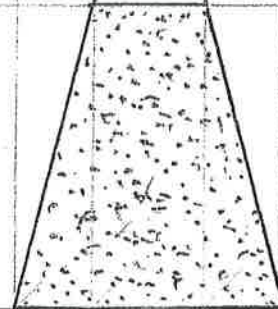
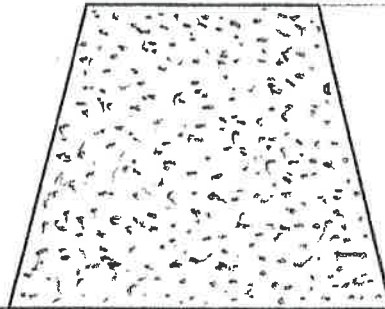
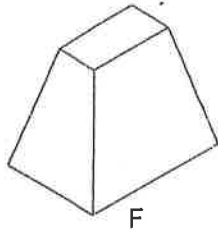

O

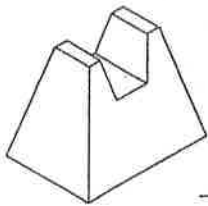
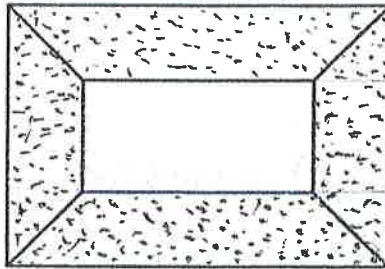

F

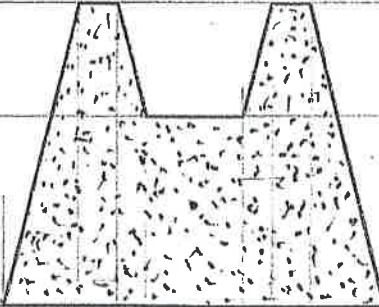

H

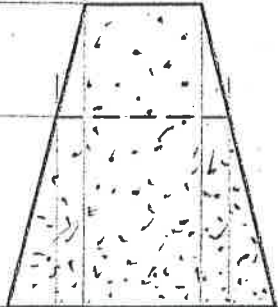

O

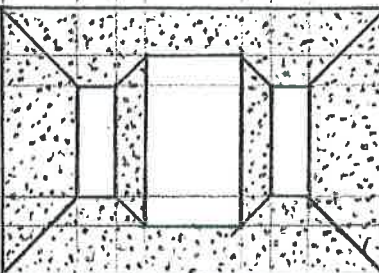

NAFN

AFA

KENNITALA

HÓPUR

DAGS.

2004

YFIRFARID

Teiknið þær línur sem vantar.

The image contains two sets of architectural drawings for a house-like object. Each set includes a front view (labeled 'F'), a side view (labeled 'H'), and an isometric view (labeled 'F'). The drawings are on a grid with construction lines. The top set shows a house with a gabled roof and a chimney. The bottom set shows a similar house but with a different roof profile. The isometric views show the 3D structure of the houses.

NAFN	KENNITALA	HÓPUR	DAGS.	YFIRFARIÐ
------	-----------	-------	-------	-----------

Teiknið þær myndir sem vantar.

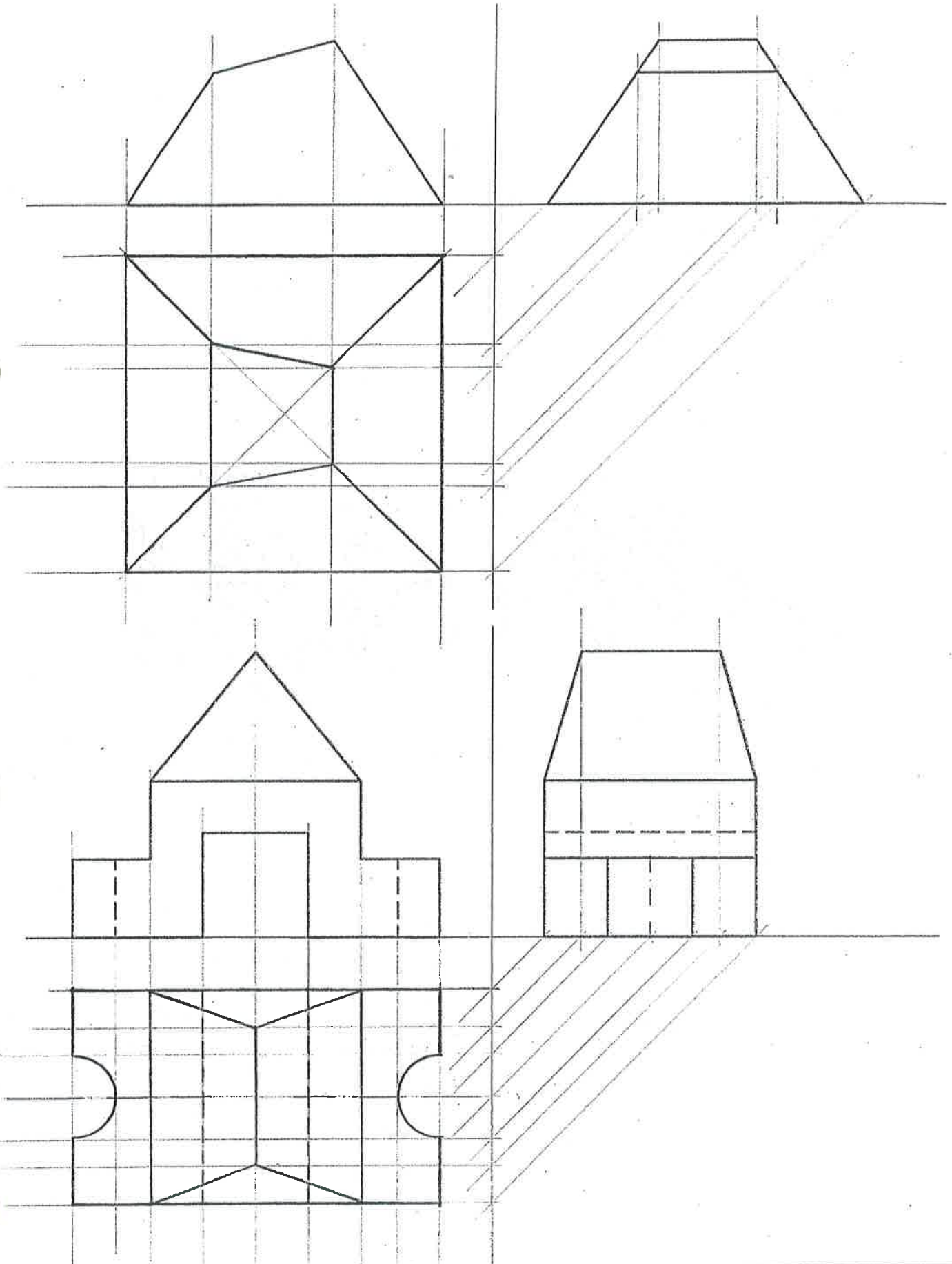

FS-145 Gættarþing - Maí 2003

NAFN

AFA

KENNITALA

HÖPUR

DAGS.

2004

YFIRFARIÐ

Teiknið þær myndir sem vantar.

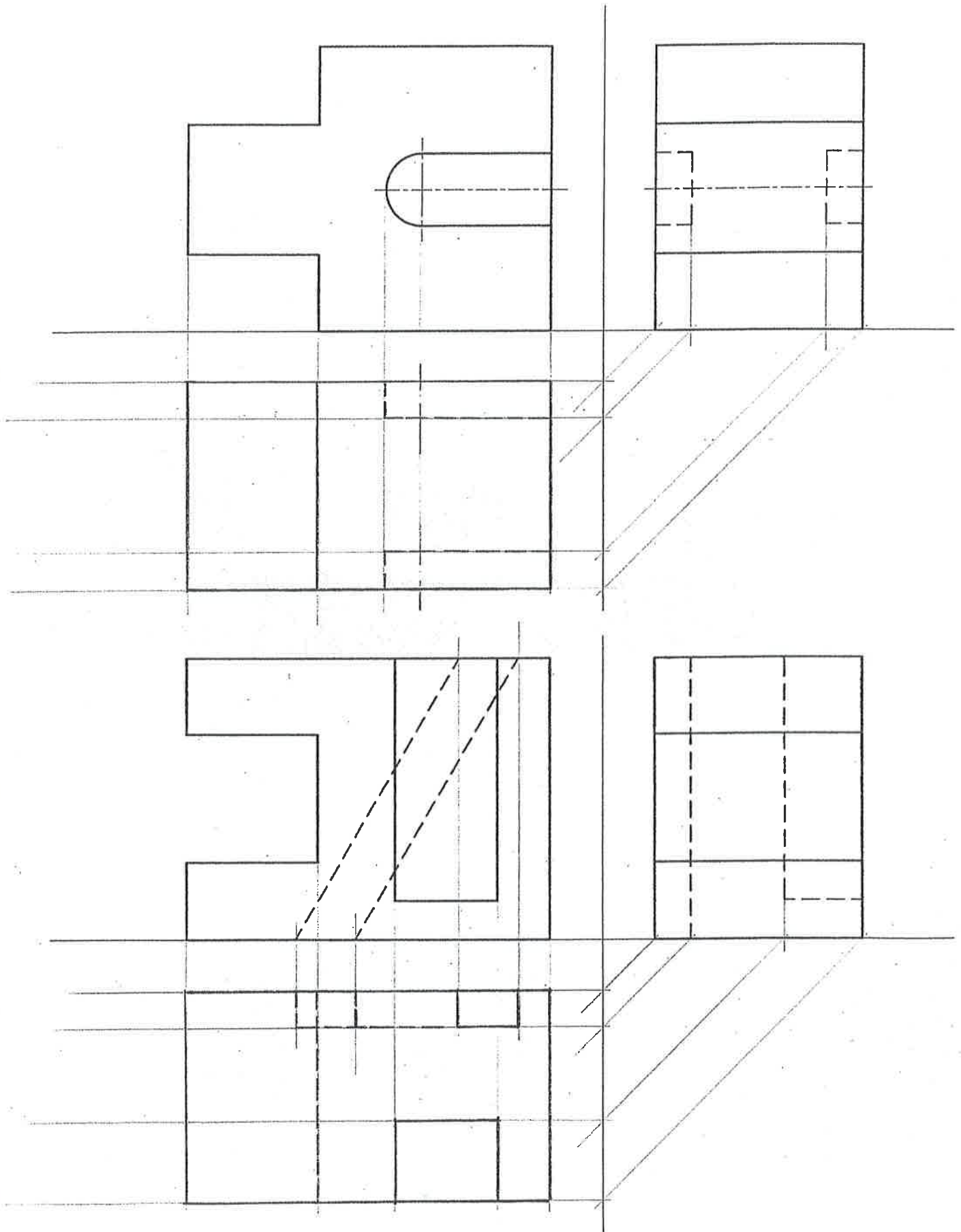

NAFN	<i>AFA</i>	KENNITALA	HÓPUR	DAGS.	<i>2004</i>	YFIRFARIÐ
------	------------	-----------	-------	-------	-------------	-----------

Séð að framan (frammyndir)

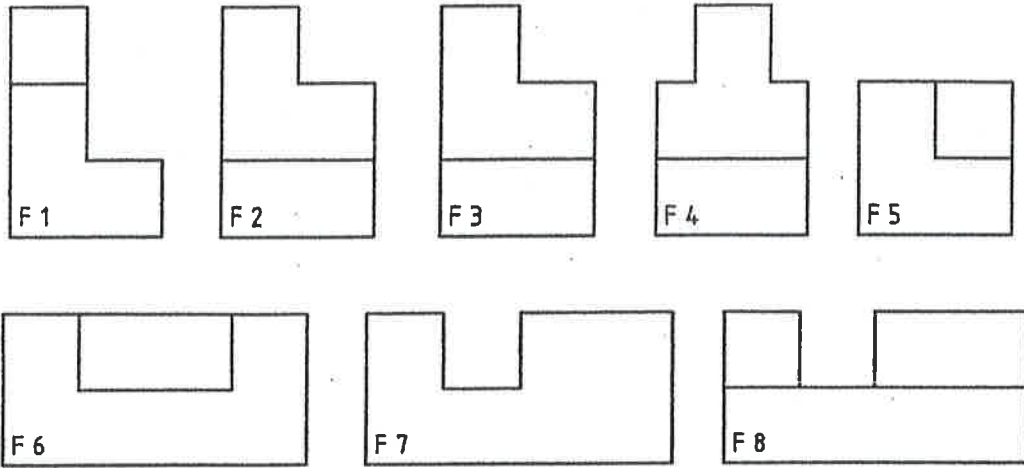

Séð frá hlið (hlíðarmyndir)

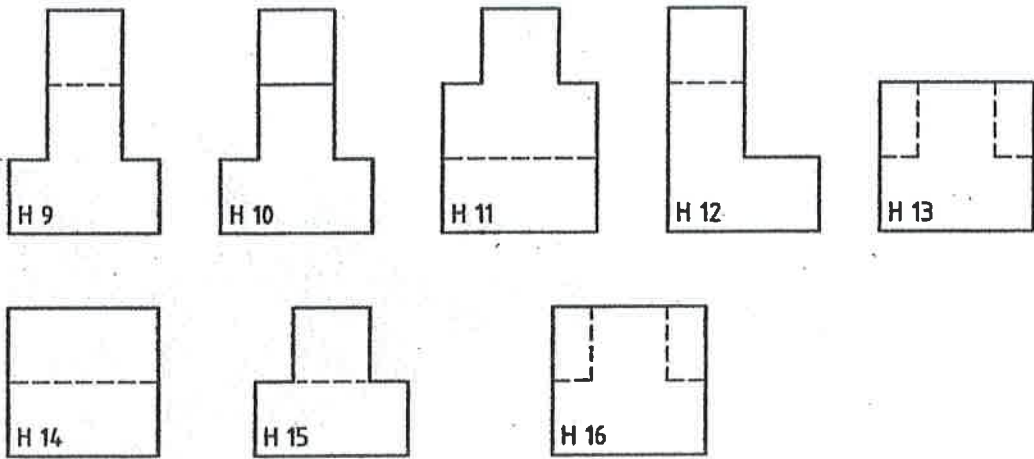

Séð að ofan (ofanmyndir)

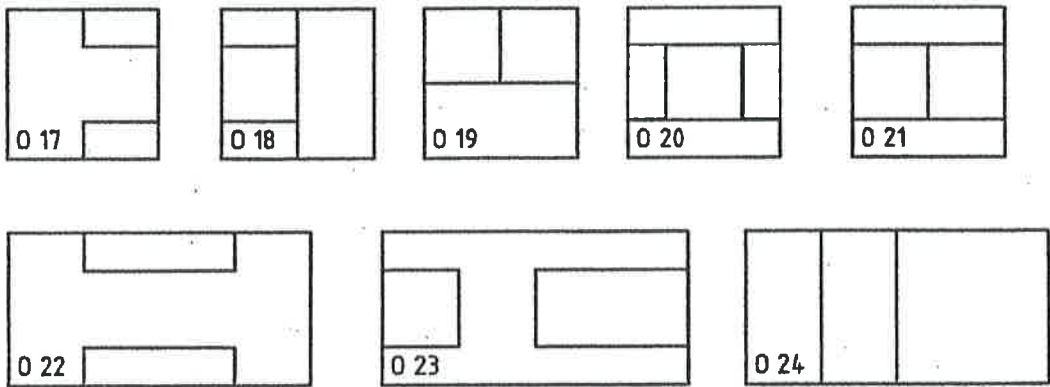

Skrifið í auðu reitina þá tölu fyrir H og O sem passar við hverja lóðrétt mynd F.

F = Séð að framan	1	2	3	4	5	6	7	8
H = Séð frá hlið	[Scribbled out]							
O = Séð að ofan								

NAFN	KENNITALA	HÓPUR	DAGS.	YFIRFARIÐ
AFA			2004	

Teiknið þær myndir sem vantar. Teiknið miðuása með strikpunktalínum.

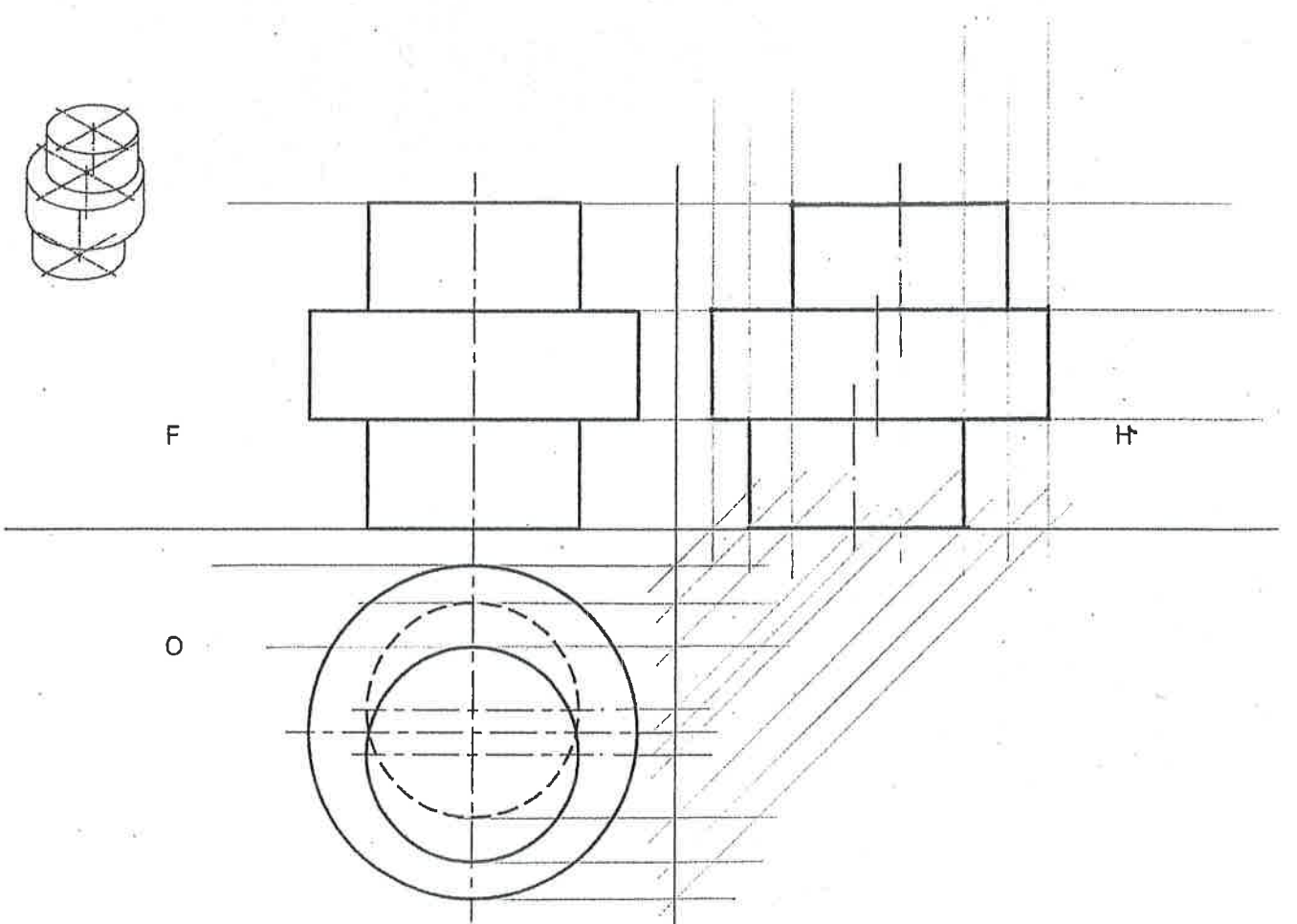
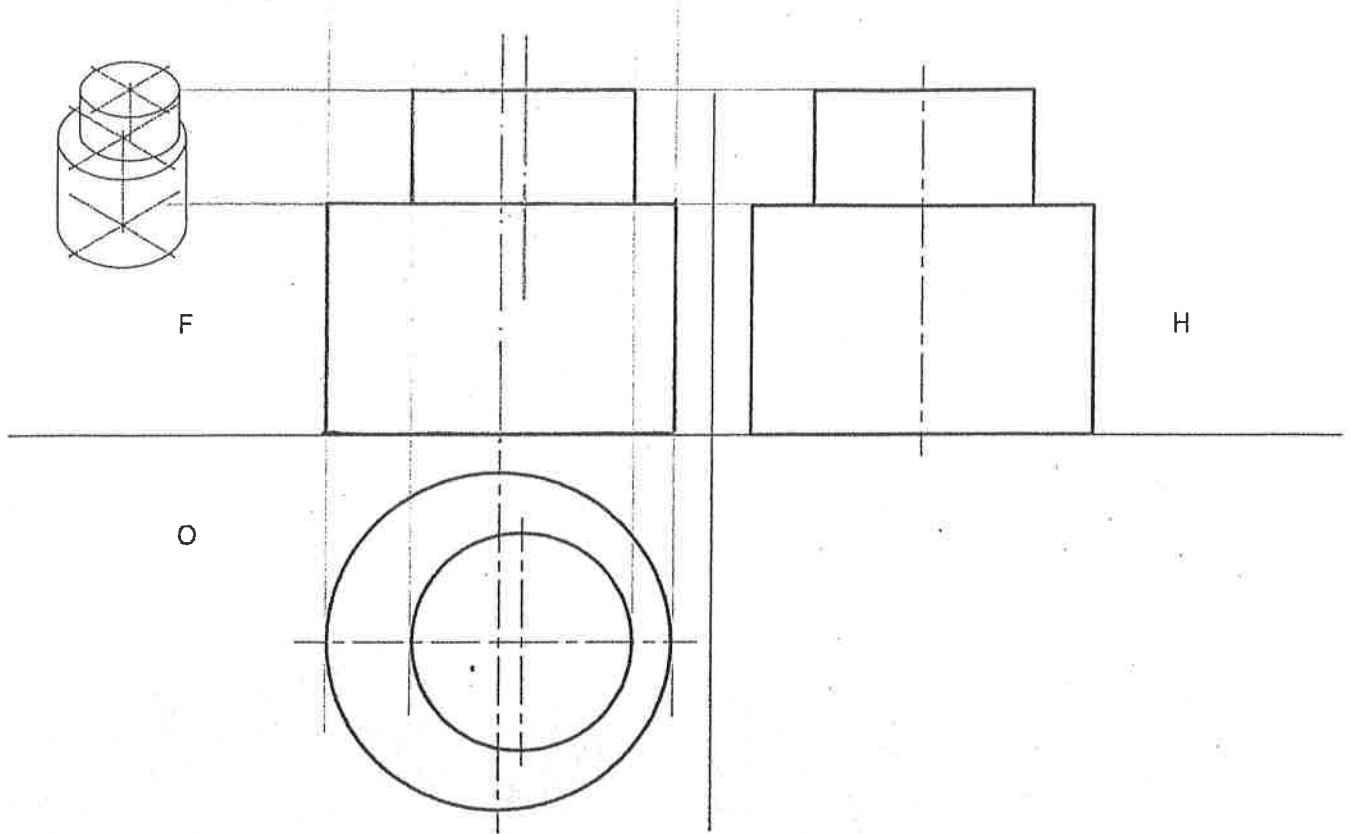

Teiknið þær myndir sem vantar. Teiknið miðjuása með stríkpunktalínum.

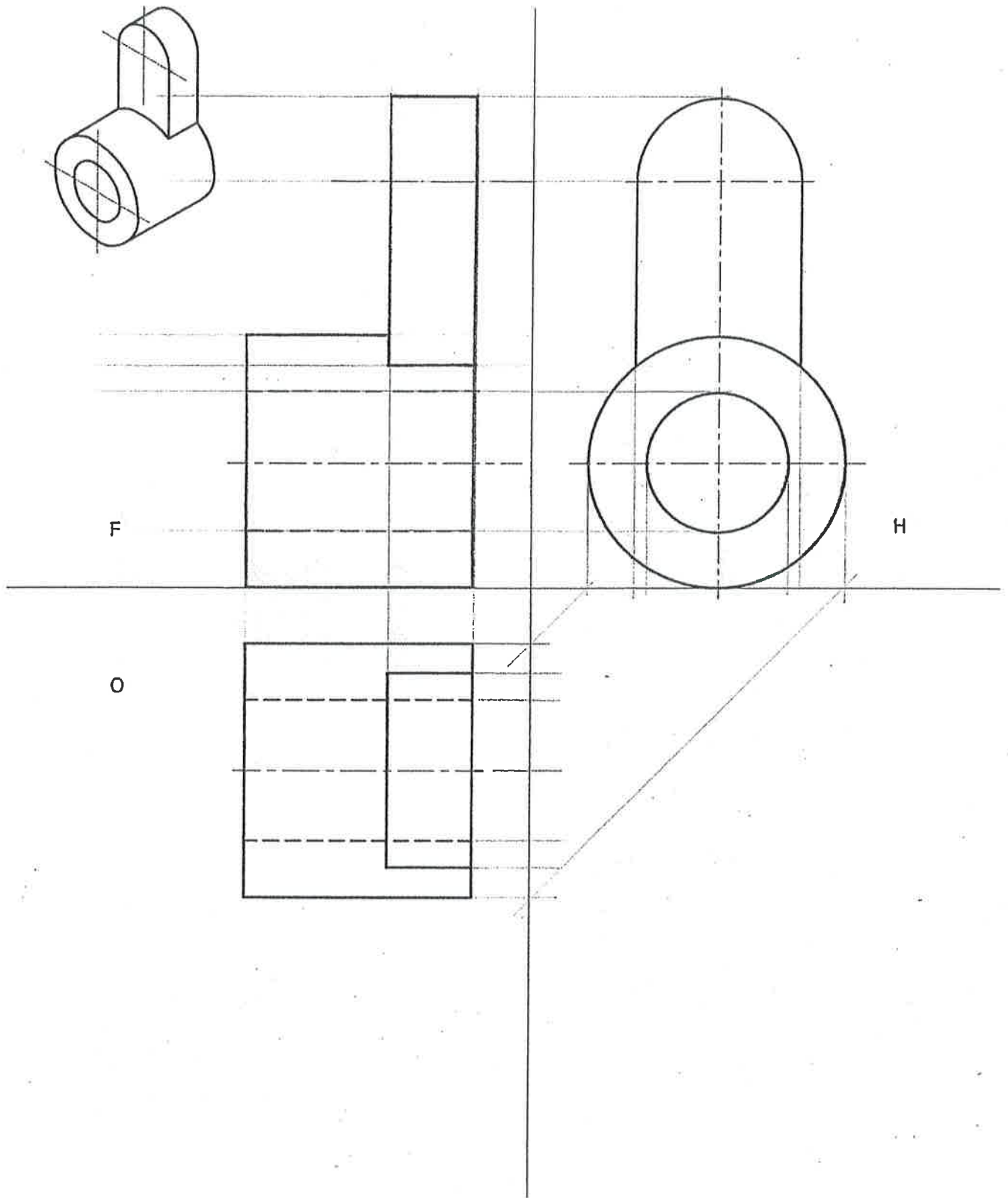

Teiknið þær myndir sem vantar.

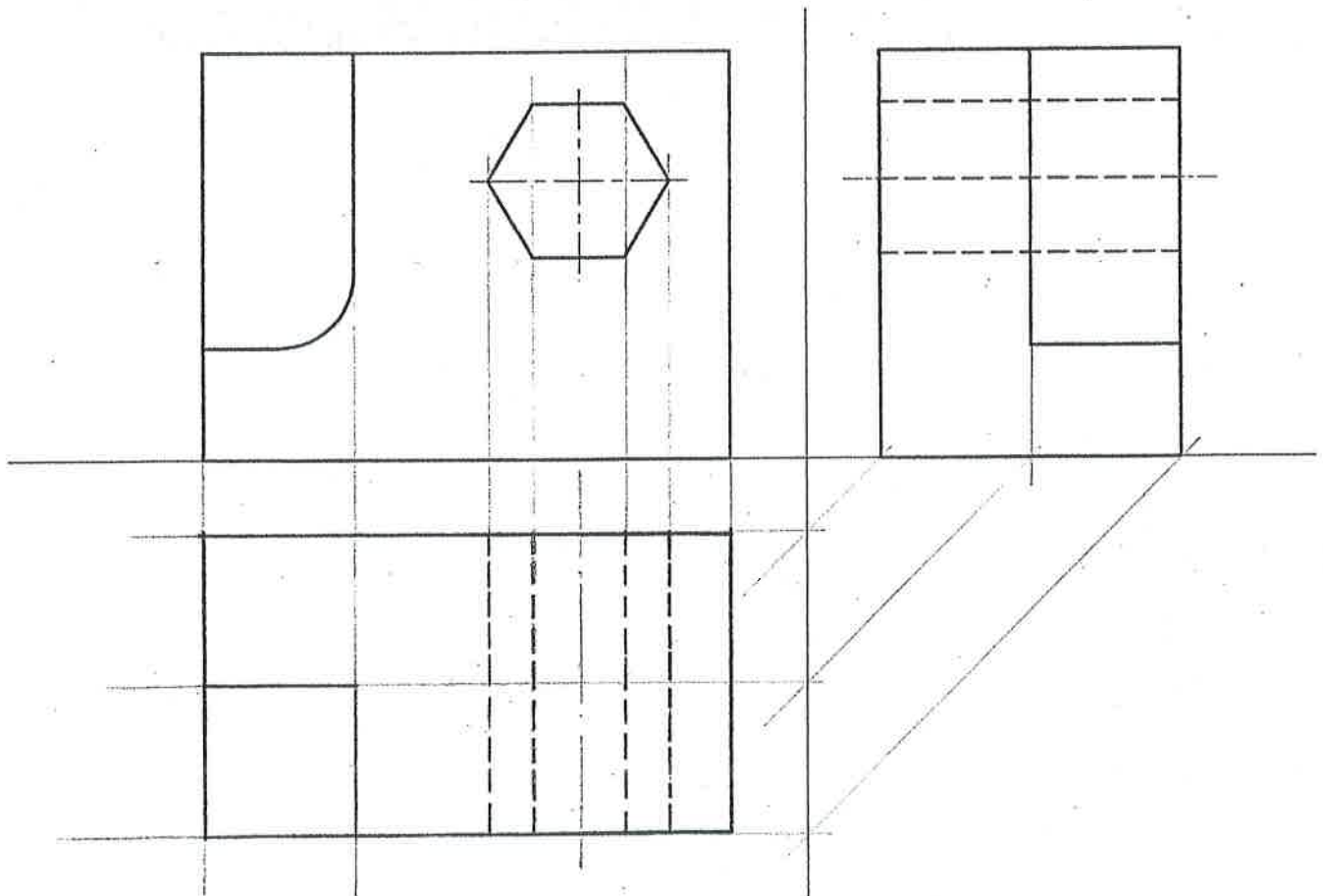
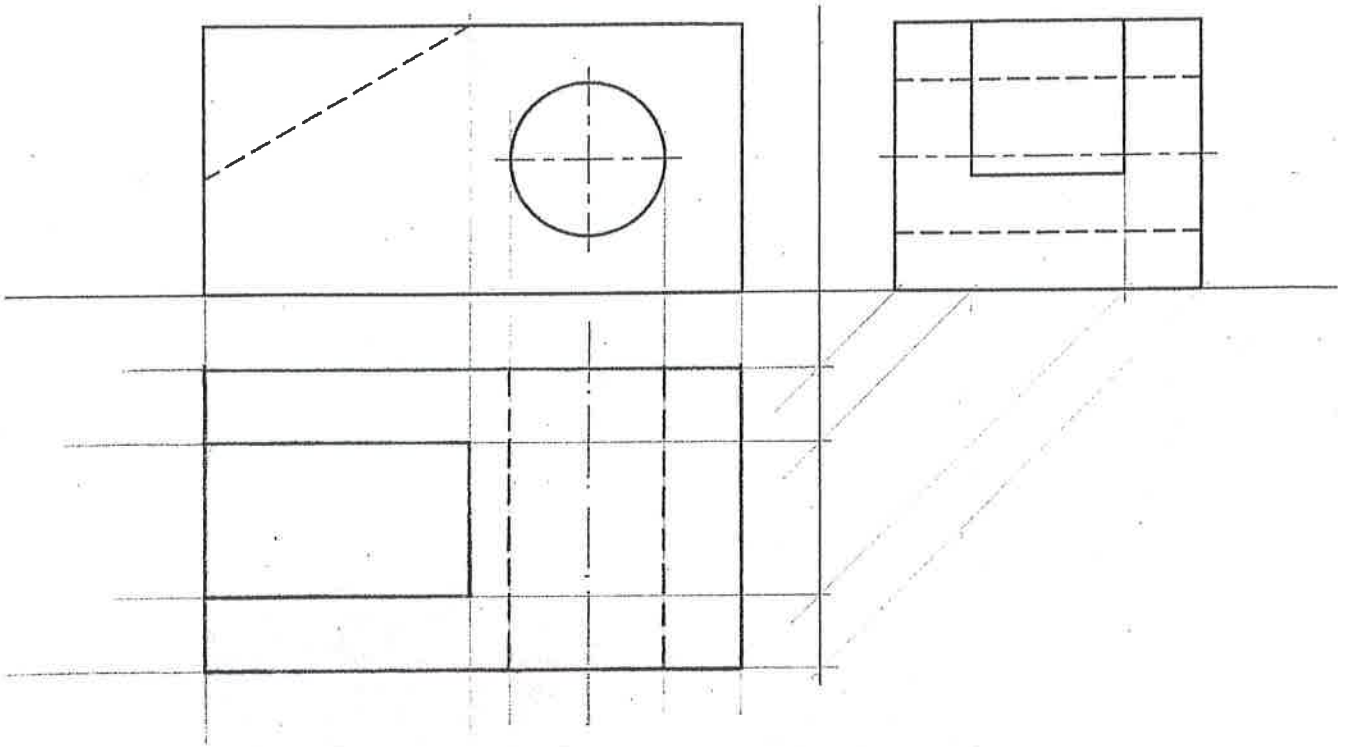

NAFN

AFA

KENNITALA

HÓPUR

DAGS.

2004

YFIRFARIÐ

Teiknið þær myndir sem vantar.

a.m.k. 3 valkostir

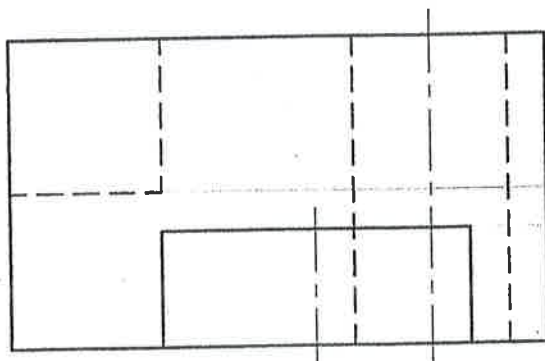
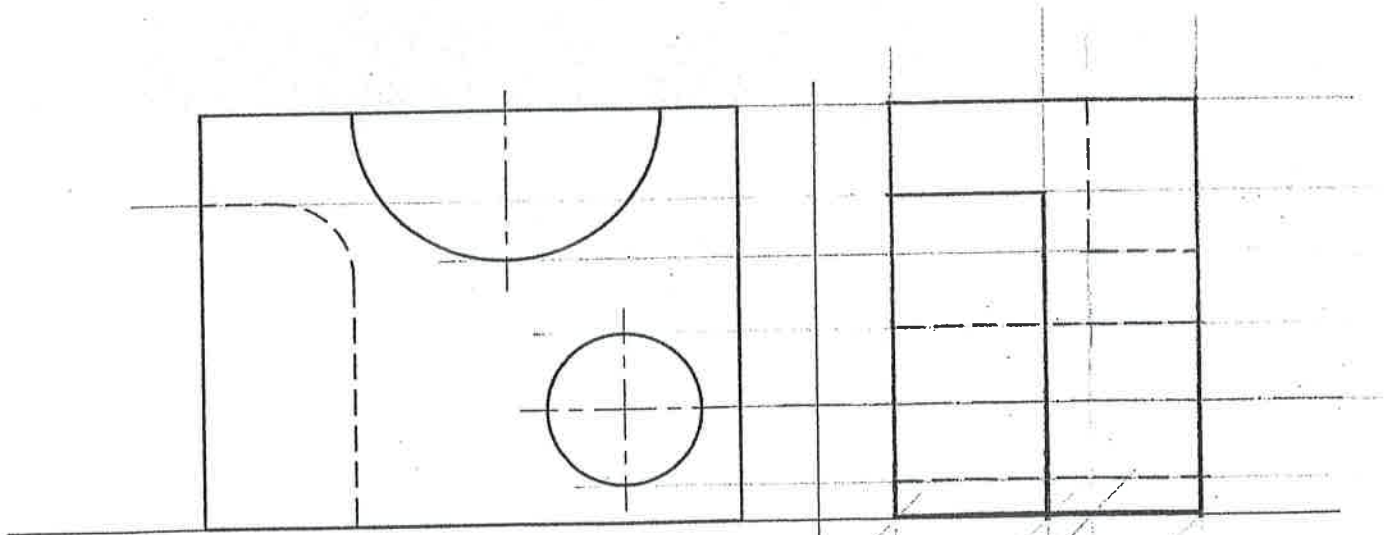
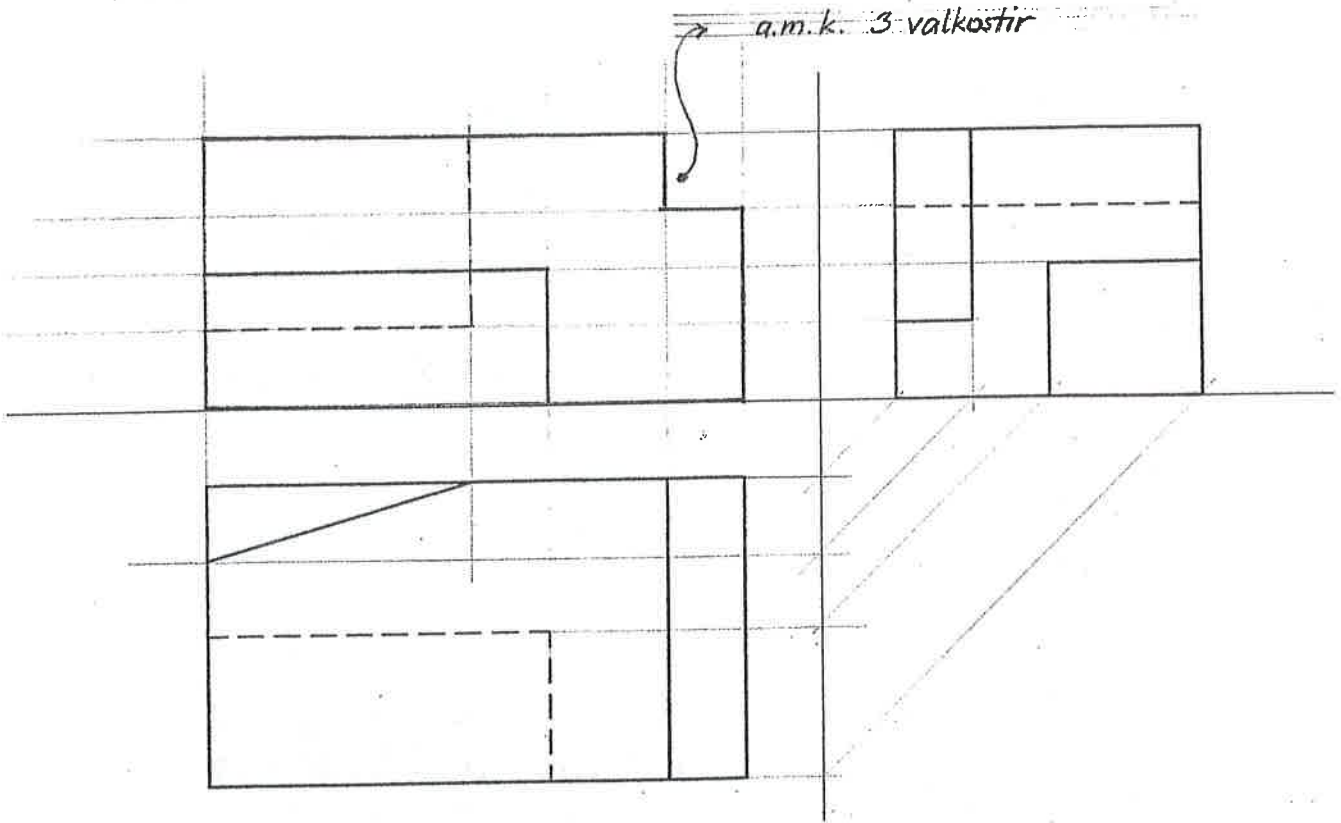

NAFN

AFA

KENNITALA

HÓPUR

DAGS.

2004

YFIRFARIÐ

Teiknið þær myndir sem vantar.

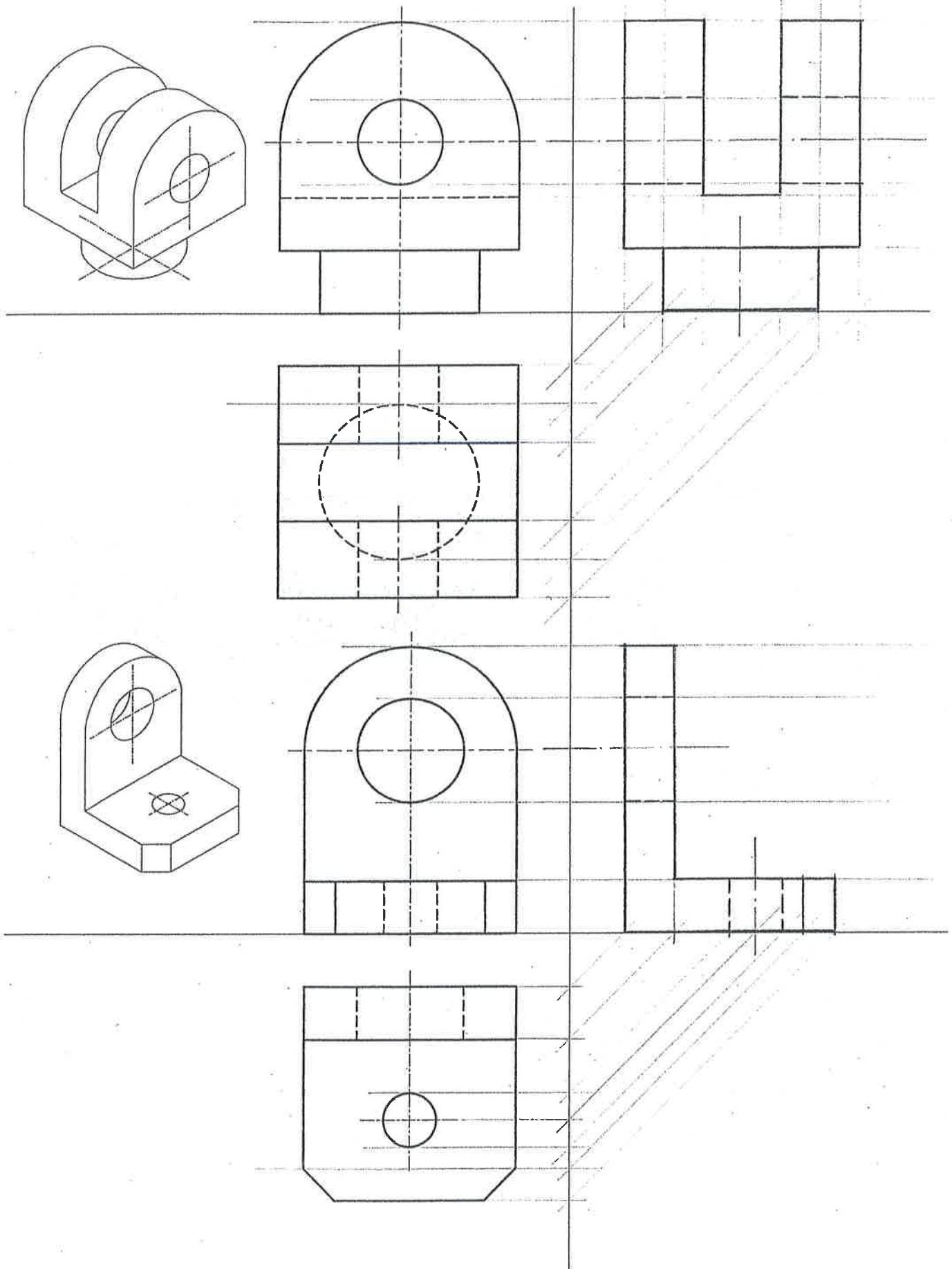

NAFN	AFA	KENNITALA	HÓPUR	DAGS.	2004	YFIRFARIÐ
------	-----	-----------	-------	-------	------	-----------

Teiknið þær myndir sem vantar.

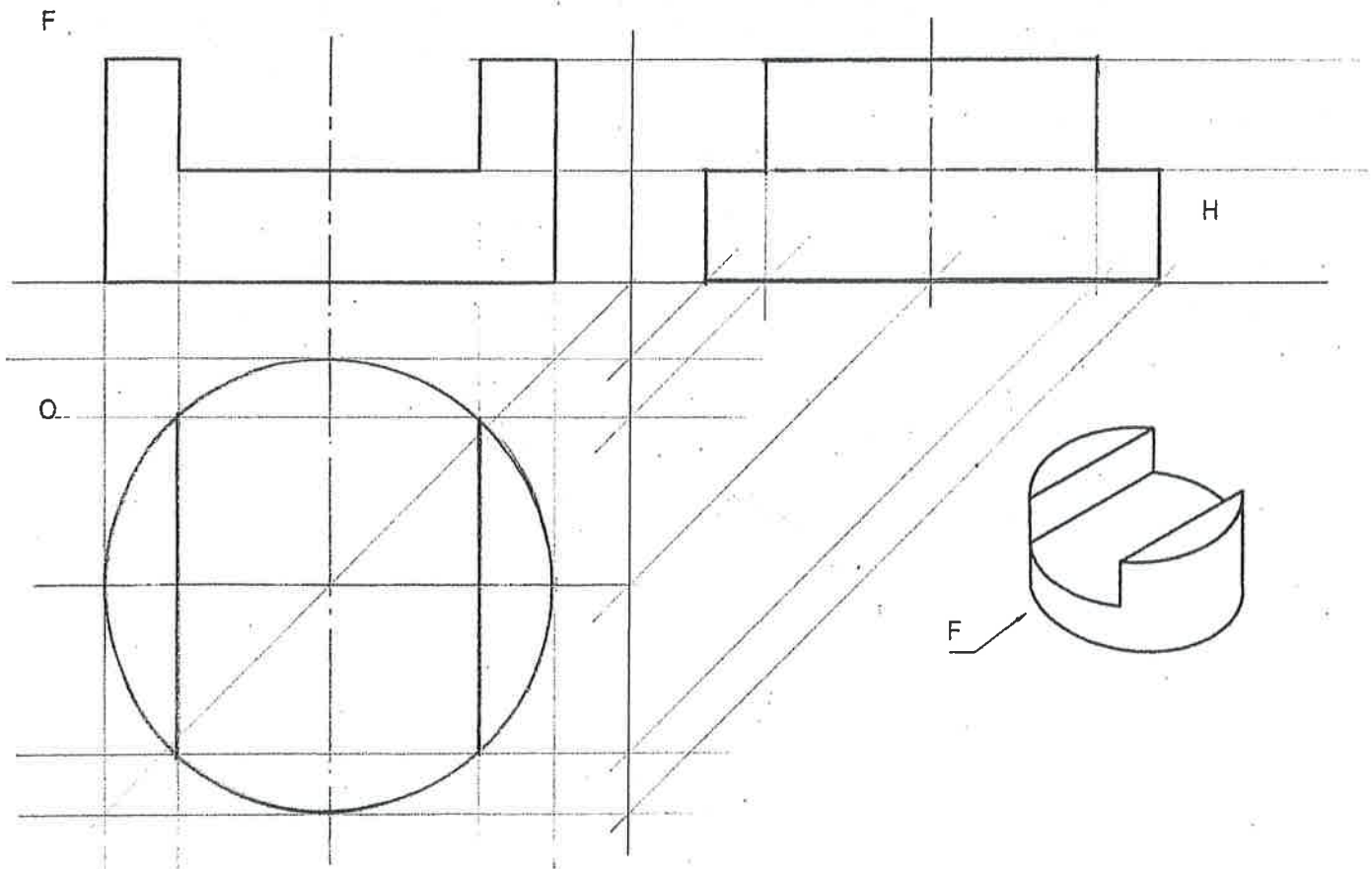
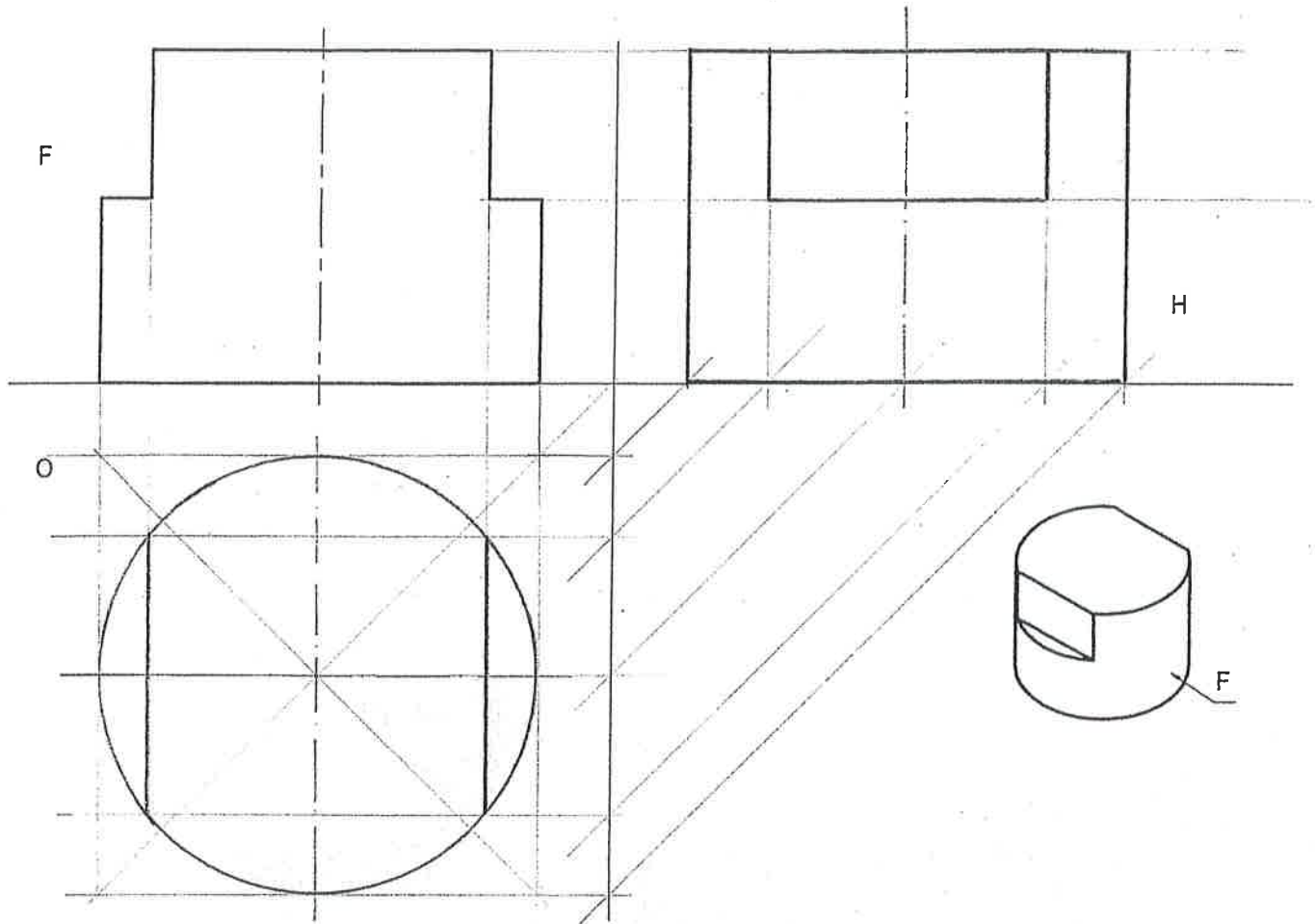

NAFN	AFA	KENNITALA	HÓPUR	DAGS.	2004	YFIRFARID
------	-----	-----------	-------	-------	------	-----------

Séð að framan (frammyndir)

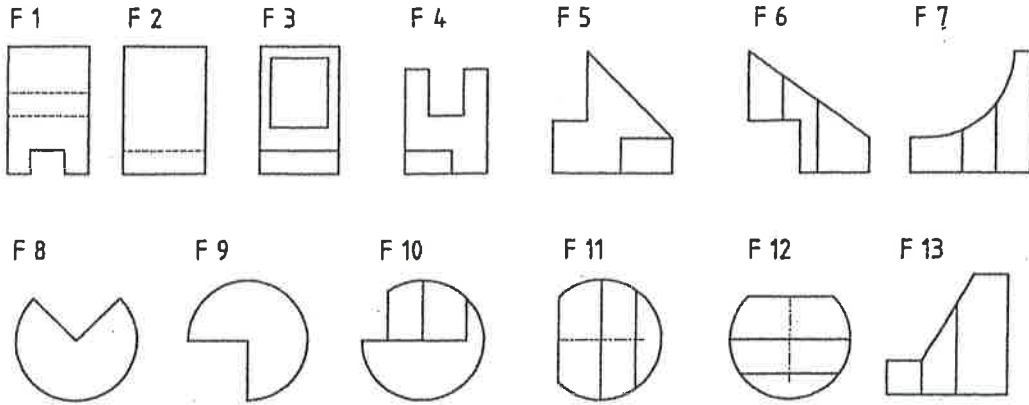

Séð frá hlið (hlöðarmyndir)

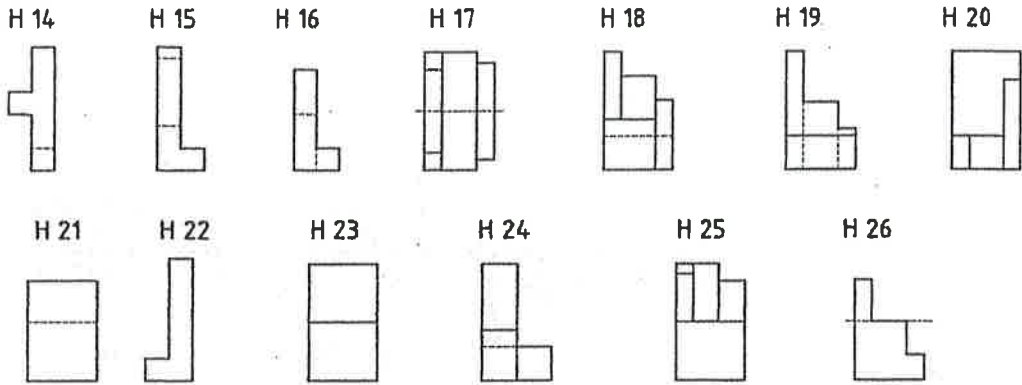

Séð að ofan (ofanmyndir)

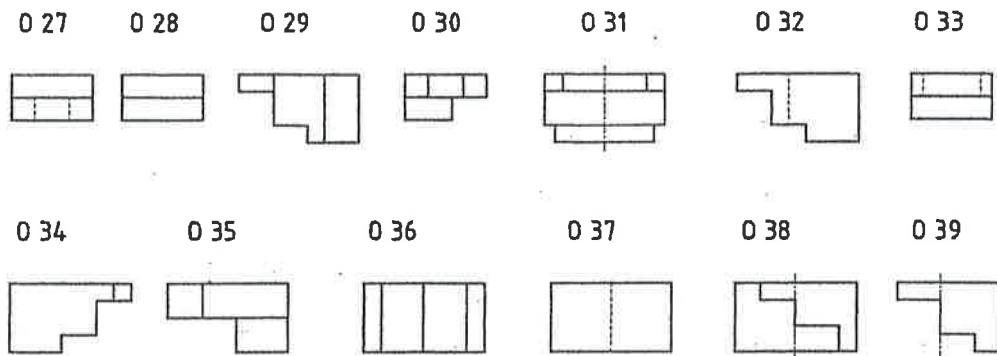





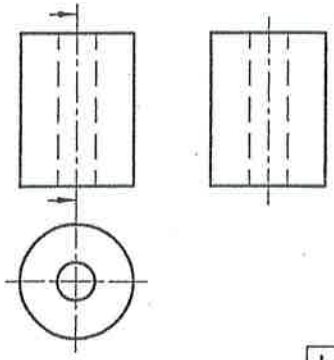
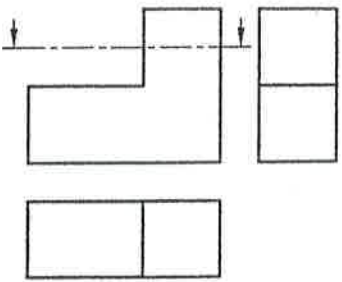

Skrifið í auðu reitina þá tölu fyrir H og O sem passar við hverja lóðréttu mynd F.

F = Séð að framan	1	2	3	4	5	6	7	8	9	10	11	12	13
H = Séð frá hlið													
O = Séð að ofan													

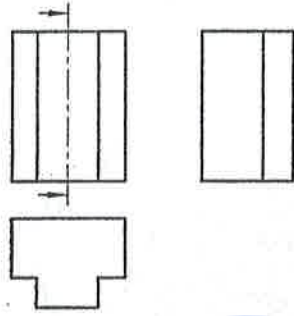
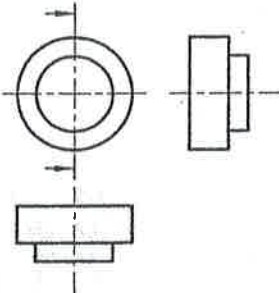
NAFN	AFA	KENNITALA	HÓPUR	DAGS.	2004	YFIRFARIÐ
------	-----	-----------	-------	-------	------	-----------

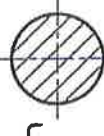
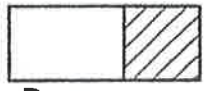
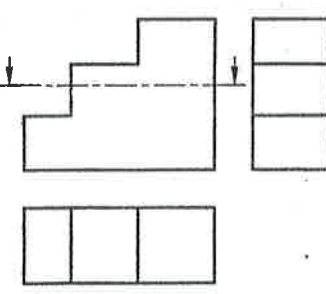
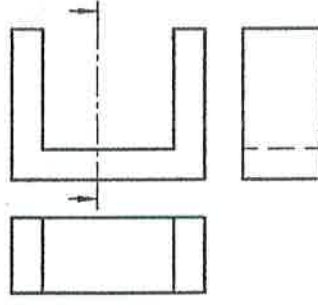
Finnið réttu sneiðmyndina. Búið er að merkja saman H og 1.

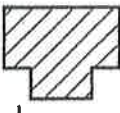
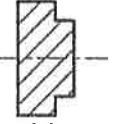
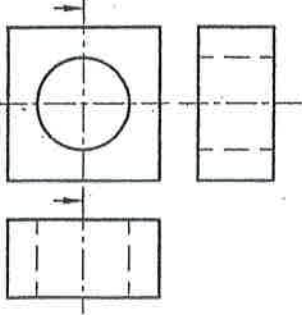
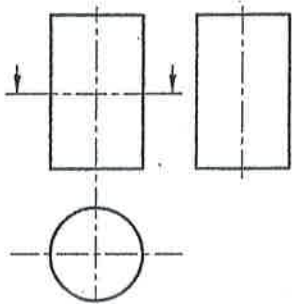
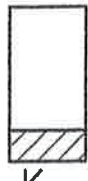
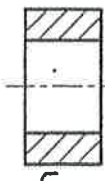
 <p style="text-align: right;">H 1</p>		 <p>F</p>  <p>P</p>
		 <p>B</p>  <p>C</p>  <p>D</p>
		 <p>A</p>  <p>R</p>  <p>J</p>  <p>M</p>
		 <p>K</p>  <p>G</p>

Finnið réttu sneiðmyndina.

		<p>C</p> <p>F</p> <p>P</p>
		<p>B</p> <p>J</p> <p>H</p>
		<p>L</p> <p>R</p> <p>A</p>
		<p>M</p> <p>K</p> <p>D</p>