

Teiknið þær myndir sem vantar og dekkið stytta fleti.

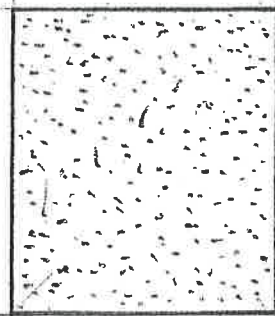
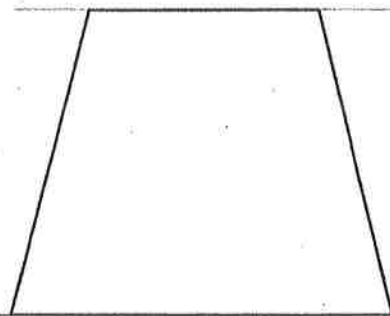
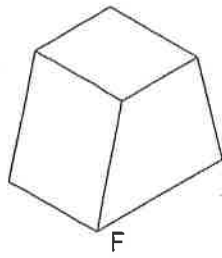

F

H

O

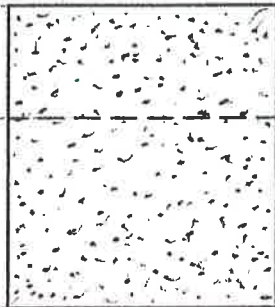
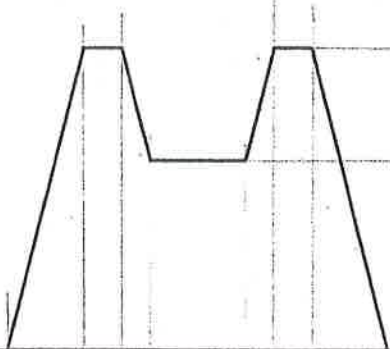
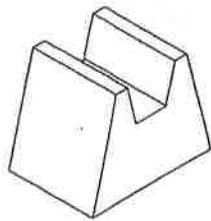
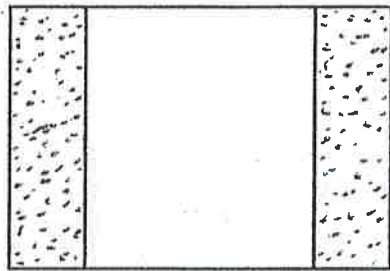

F

H

O

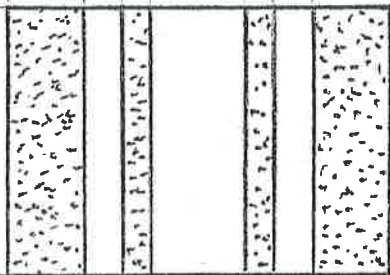

Teiknið þær myndir sem vantar og dekkið stytta fleti.

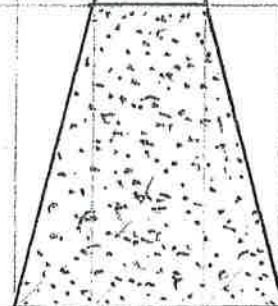
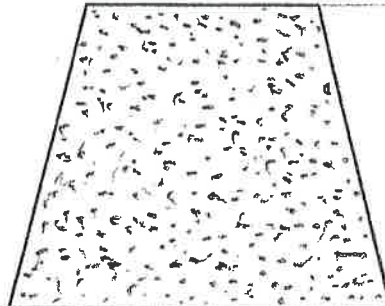
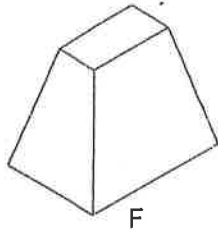

O

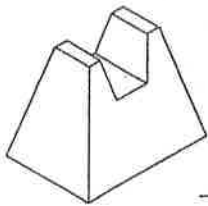
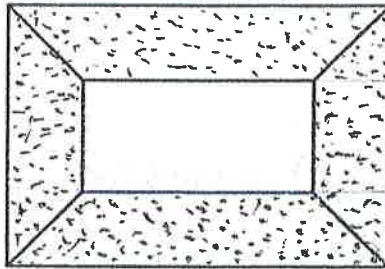

F

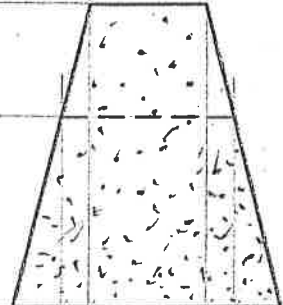
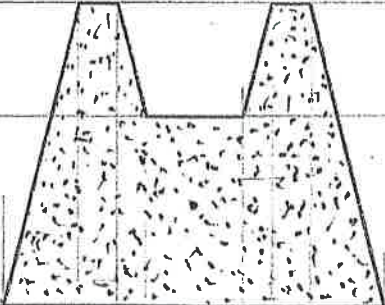

O

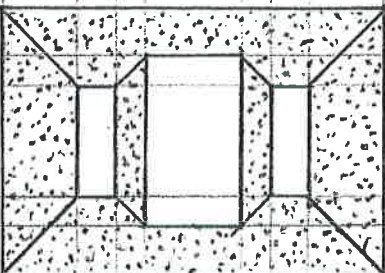

NAFN

AFA

KENNITALA

HÓPUR

DAGS.

2004

YFIRFARID

Teiknið þær línur sem vantar.

The image contains two sets of architectural drawings. Each set consists of a front view (labeled 'F'), a side view (labeled 'H'), and an isometric view (labeled 'F'). The drawings are on a grid with construction lines. The top set shows a house with a gabled roof and a chimney. The bottom set shows a similar house but with a different roof profile. The isometric views show the 3D structure of the houses.

NAFN	KENNITALA	HÓPUR	DAGS.	YFIRFARIÐ
------	-----------	-------	-------	-----------

Teiknið þær myndir sem vantar.

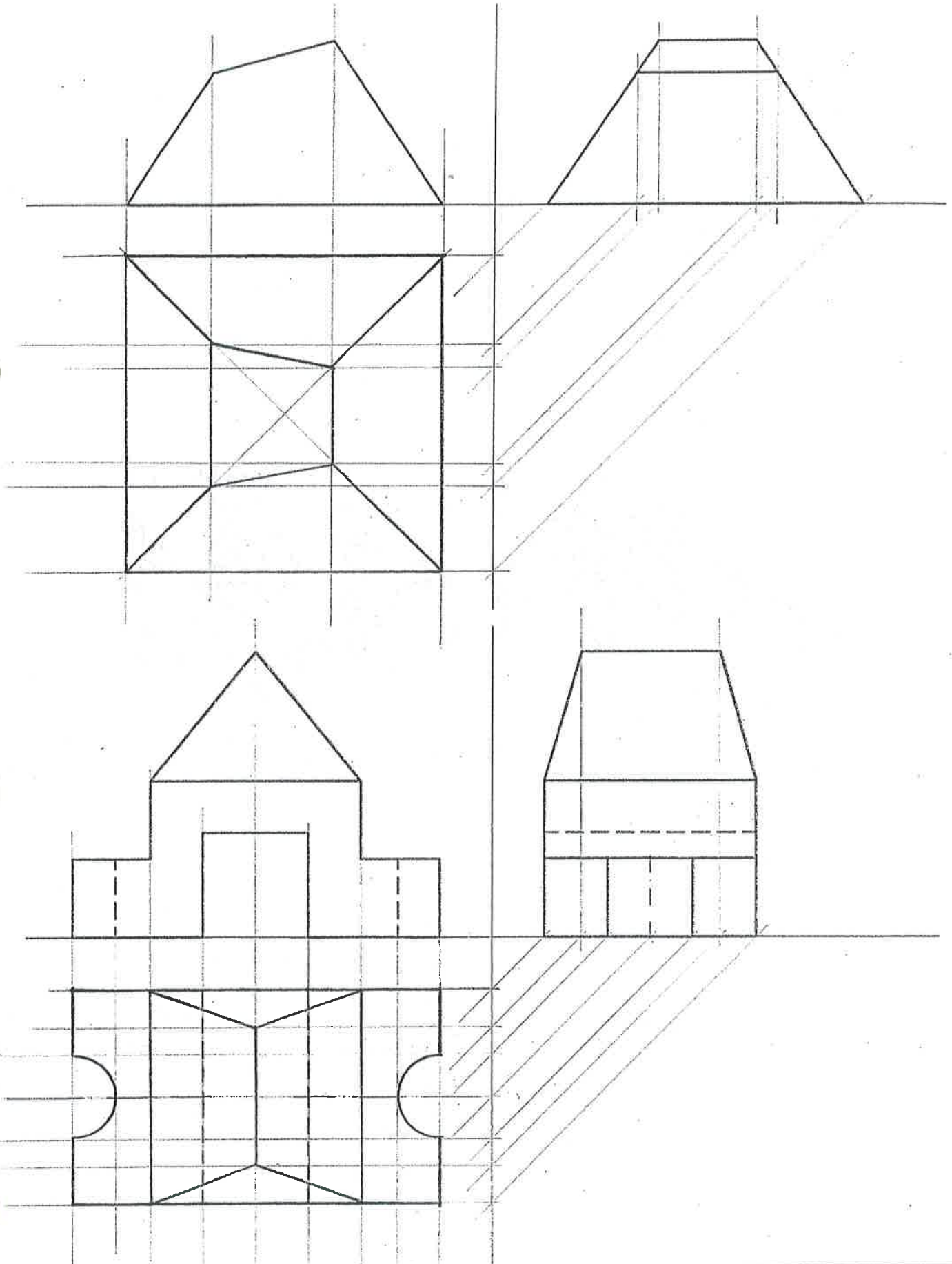

FS-145 Gættarþing - Maí 2003

NAFN

AFA

KENNITALA

HÖPUR

DAGS.

2004

YFIRFARIÐ

Teiknið þær myndir sem vantar.

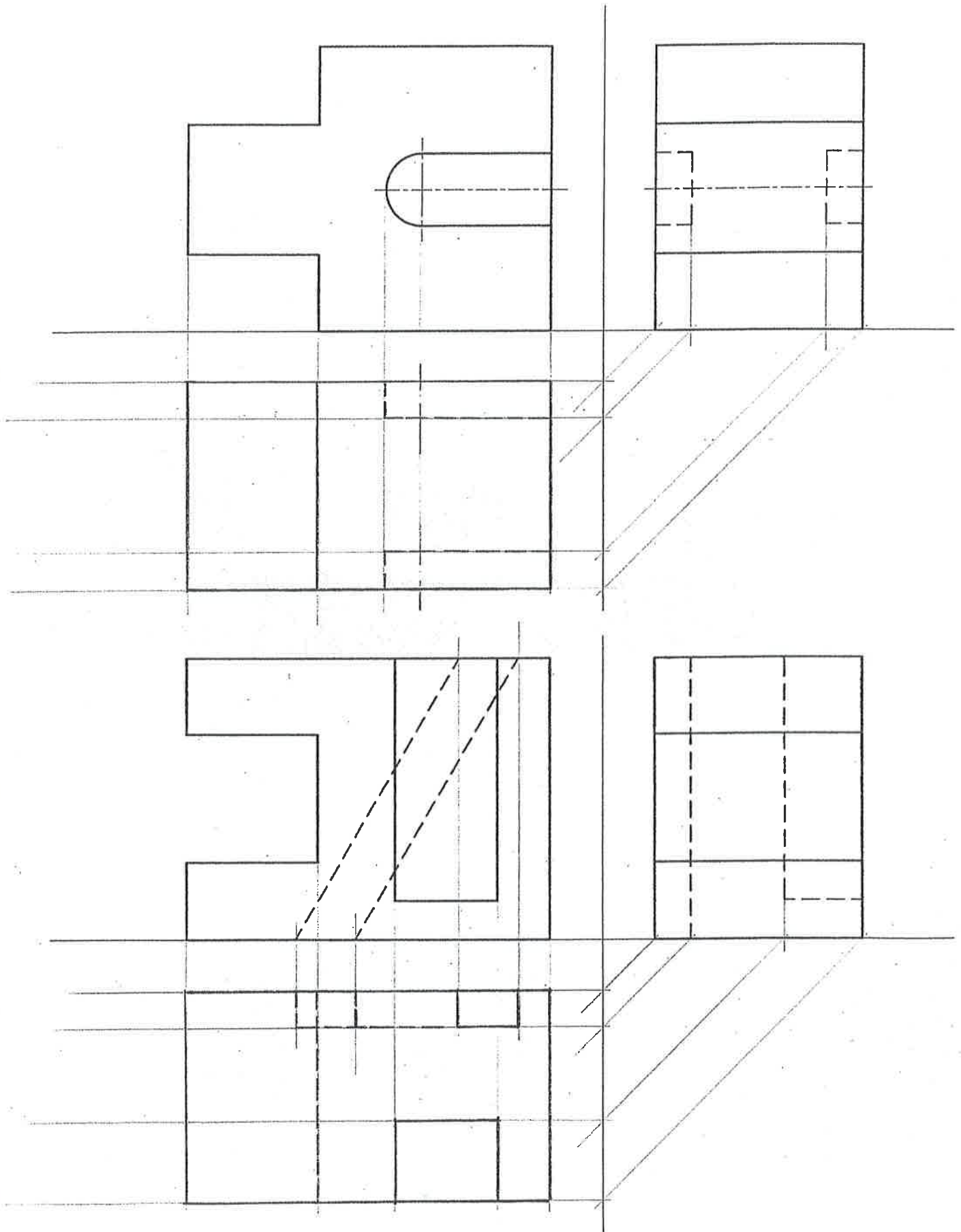

Séð að framan (frammyndir)

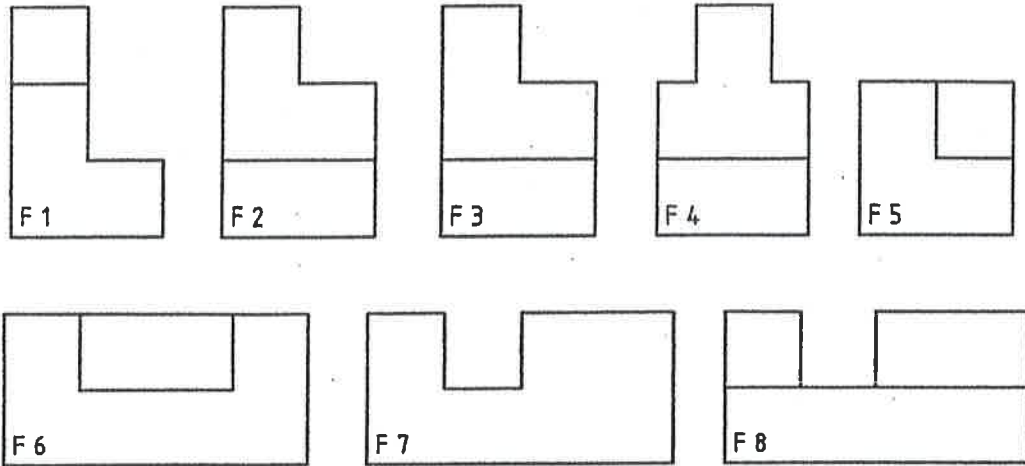

Séð frá hlið (hlíðarmyndir)

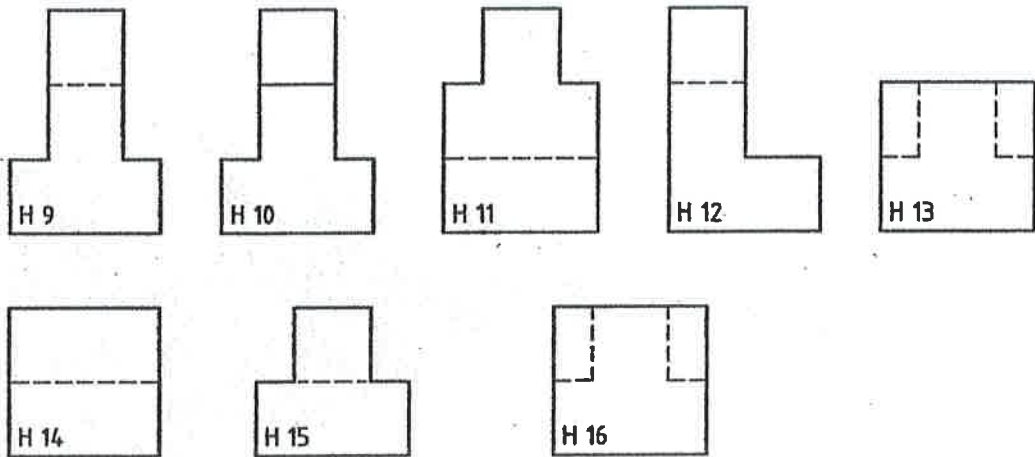

Séð að ofan (ofanmyndir)

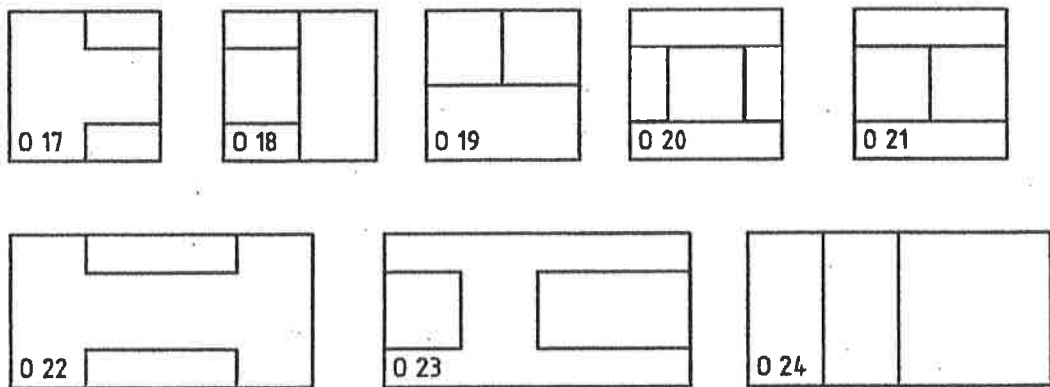

Skrifið í auðu reitina þá tölu fyrir H og O sem passar við hverja lóðrétt mynd F.

F = Séð að framan	1	2	3	4	5	6	7	8
H = Séð frá hlið		12			13/16			15
O = Séð að ofan	18		21	20			24	

NAFN	AFA	KENNITALA	HÓPUR	DAGS.	2004	YFIRFARIÐ
------	-----	-----------	-------	-------	------	-----------

Teiknið þær myndir sem vantar. Teiknið miðuása með strikpunktalínum.

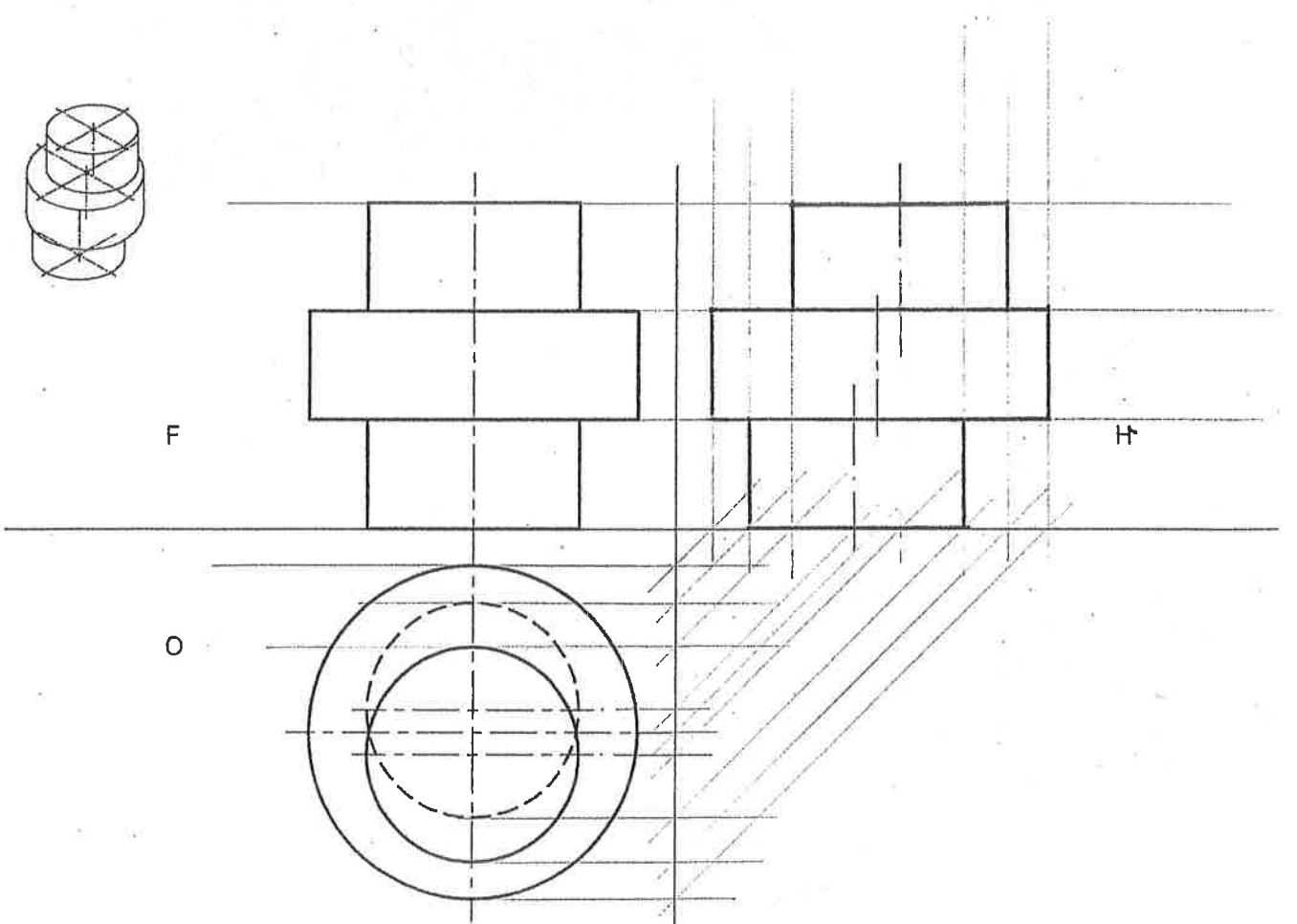
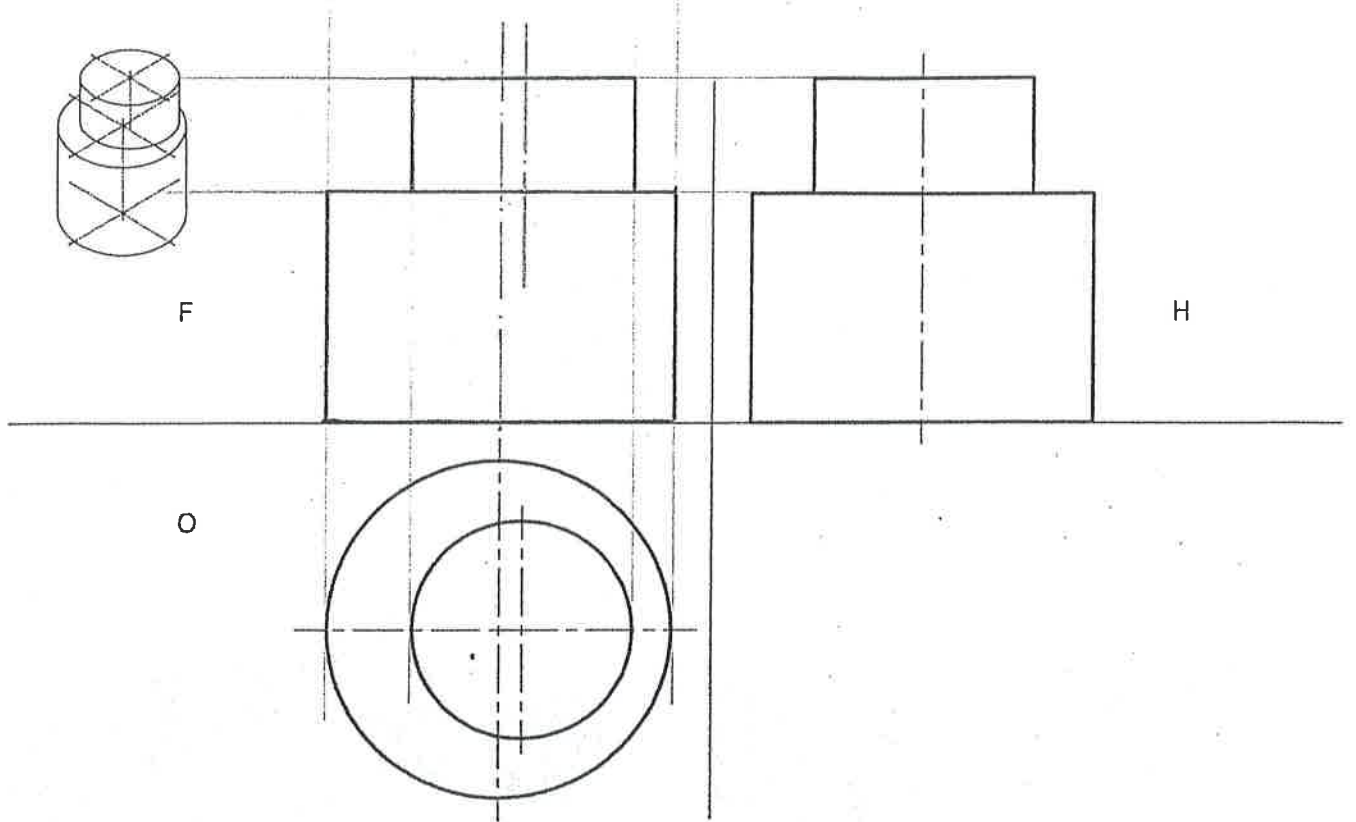

Teiknið þær myndir sem vantar. Teiknið miðjuása með strikpunktalínum.

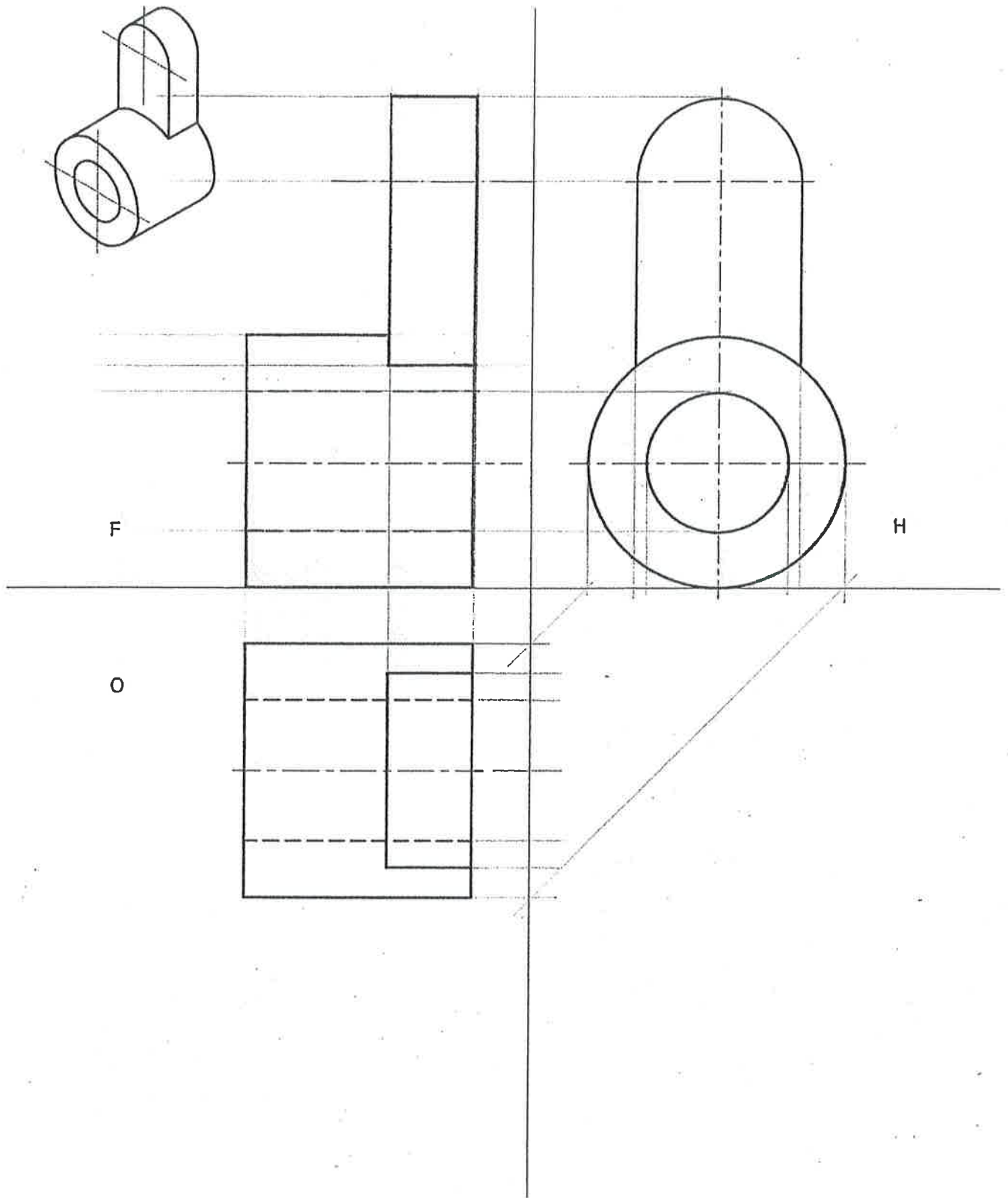

NAFN	AFA	KENNITALA	HÓPUR	DAGS.	2004	YFIRFARIÐ
------	-----	-----------	-------	-------	------	-----------



Teiknið þær myndir sem vantar.

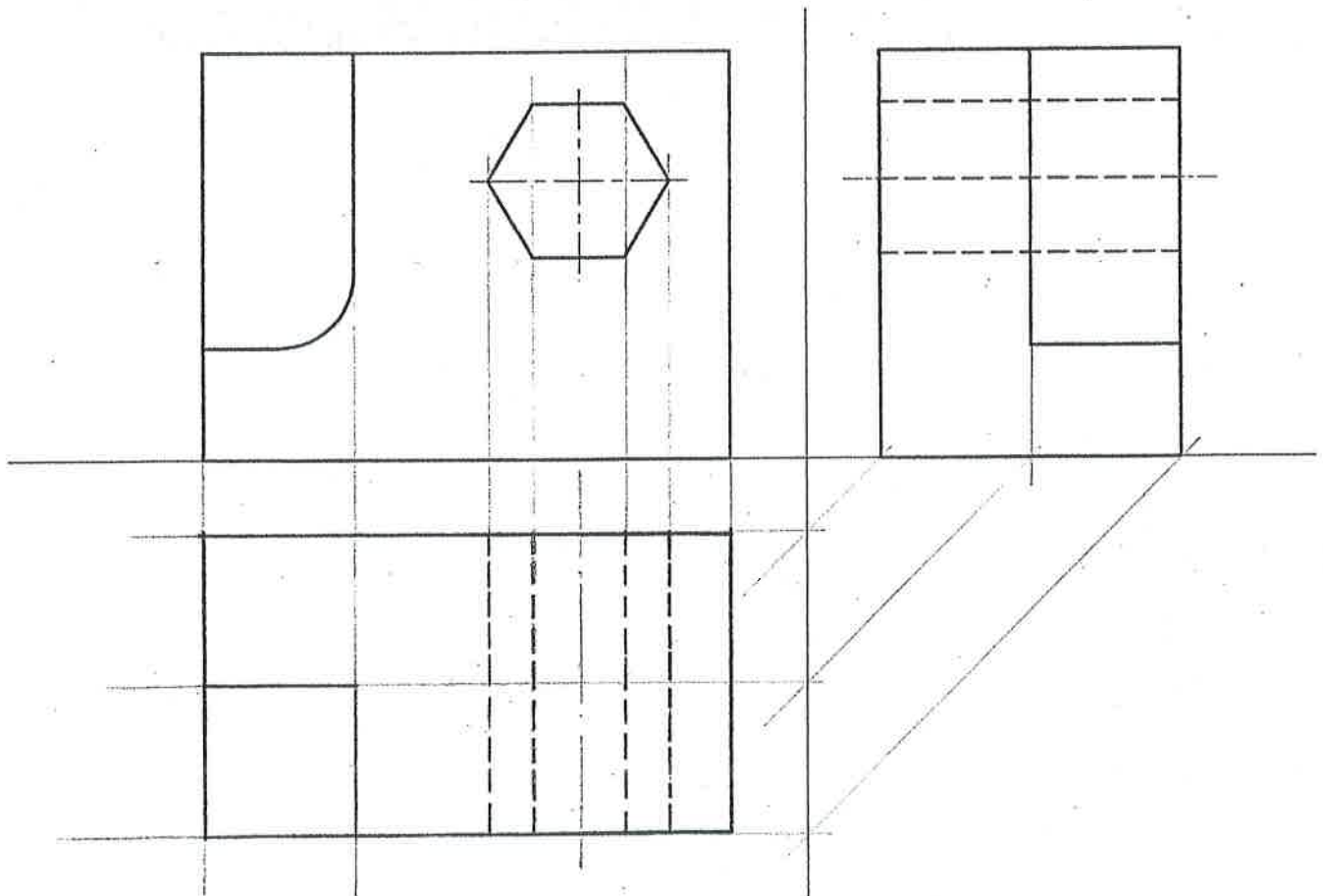
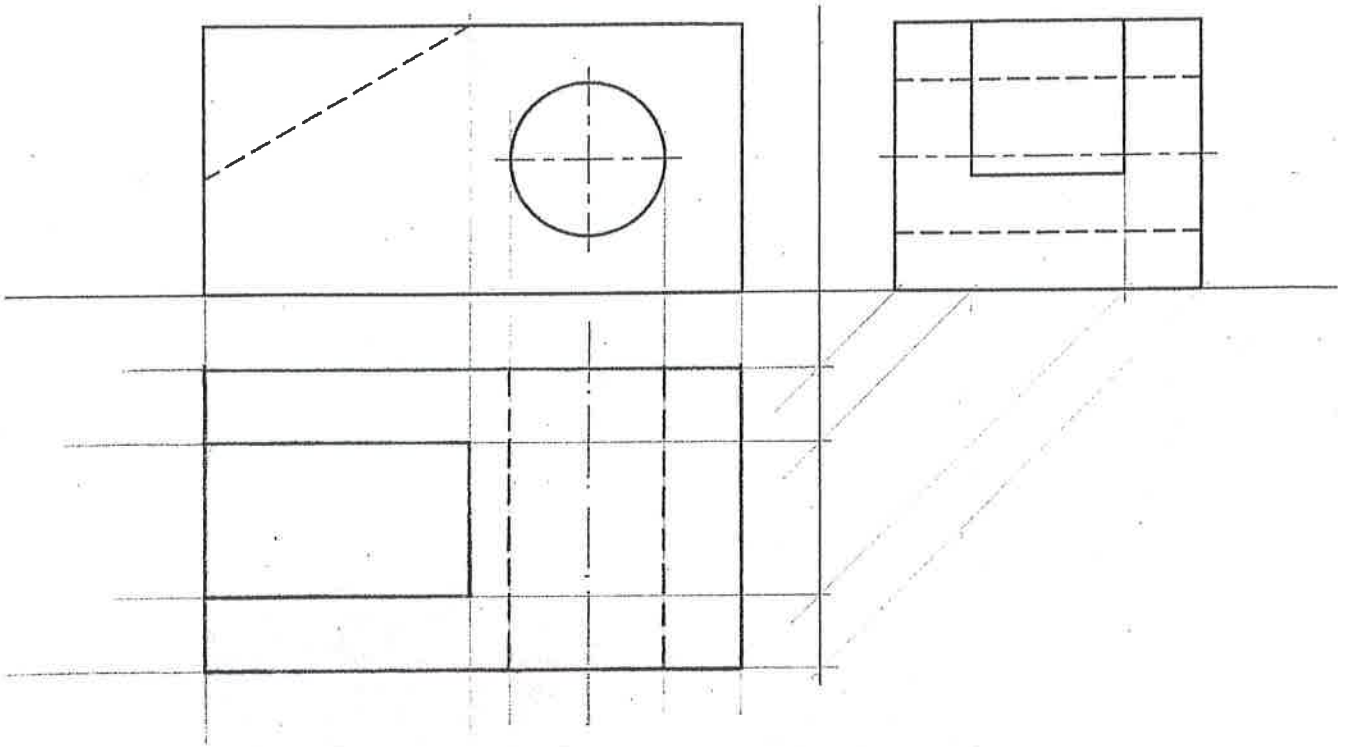

NAFN

AFA

KENNITALA

HÓPUR

DAGS.

2004

YFIRFARIÐ

Teiknið þær myndir sem vantar.

a.m.k. 3 valkostir

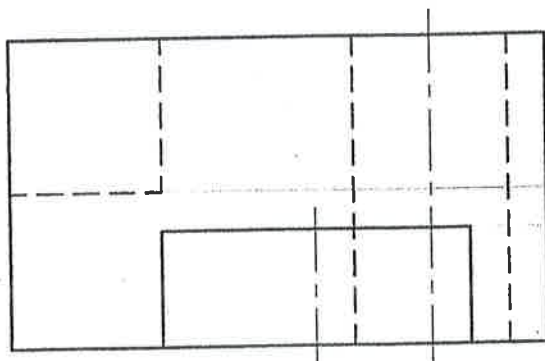
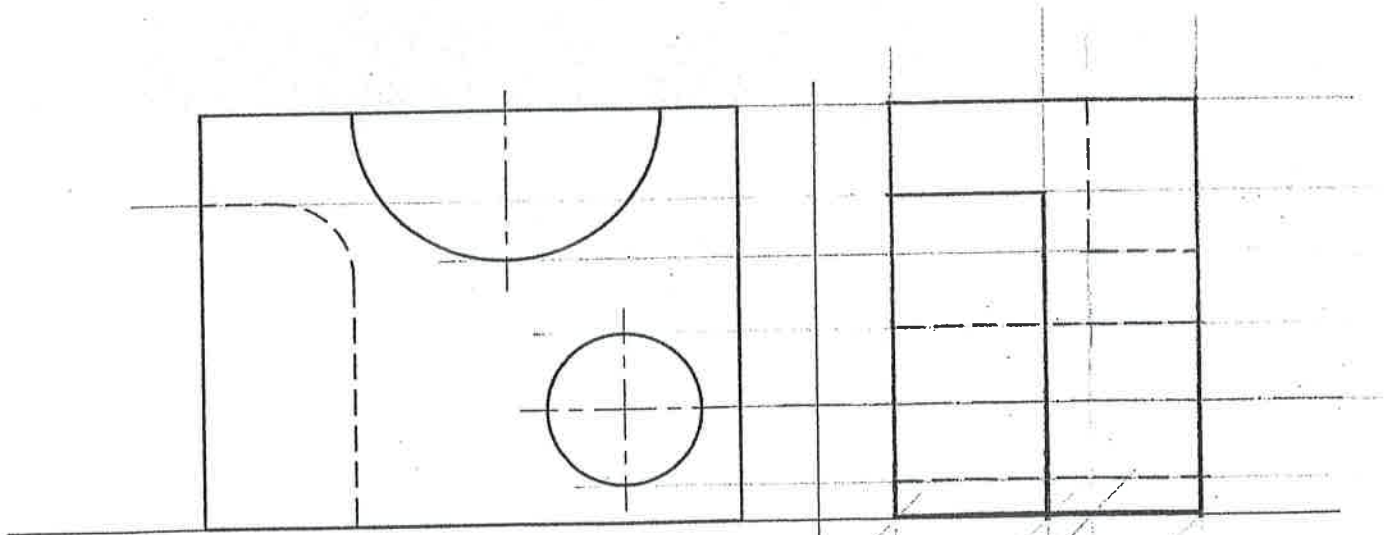
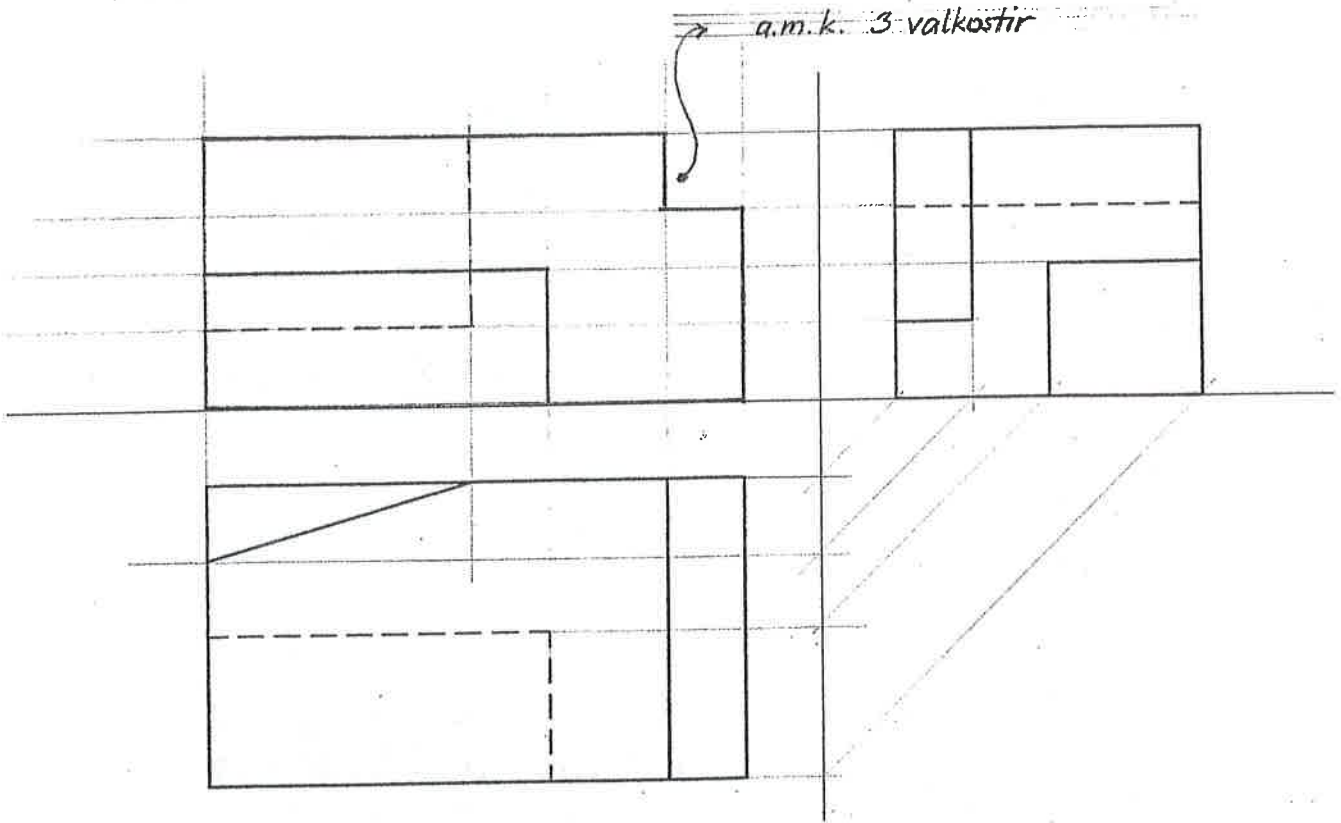

NAFN

AFA

KENNITALA

HÓPUR

DAGS.

2004

YFIRFARIÐ

Teiknið þær myndir sem vantar.

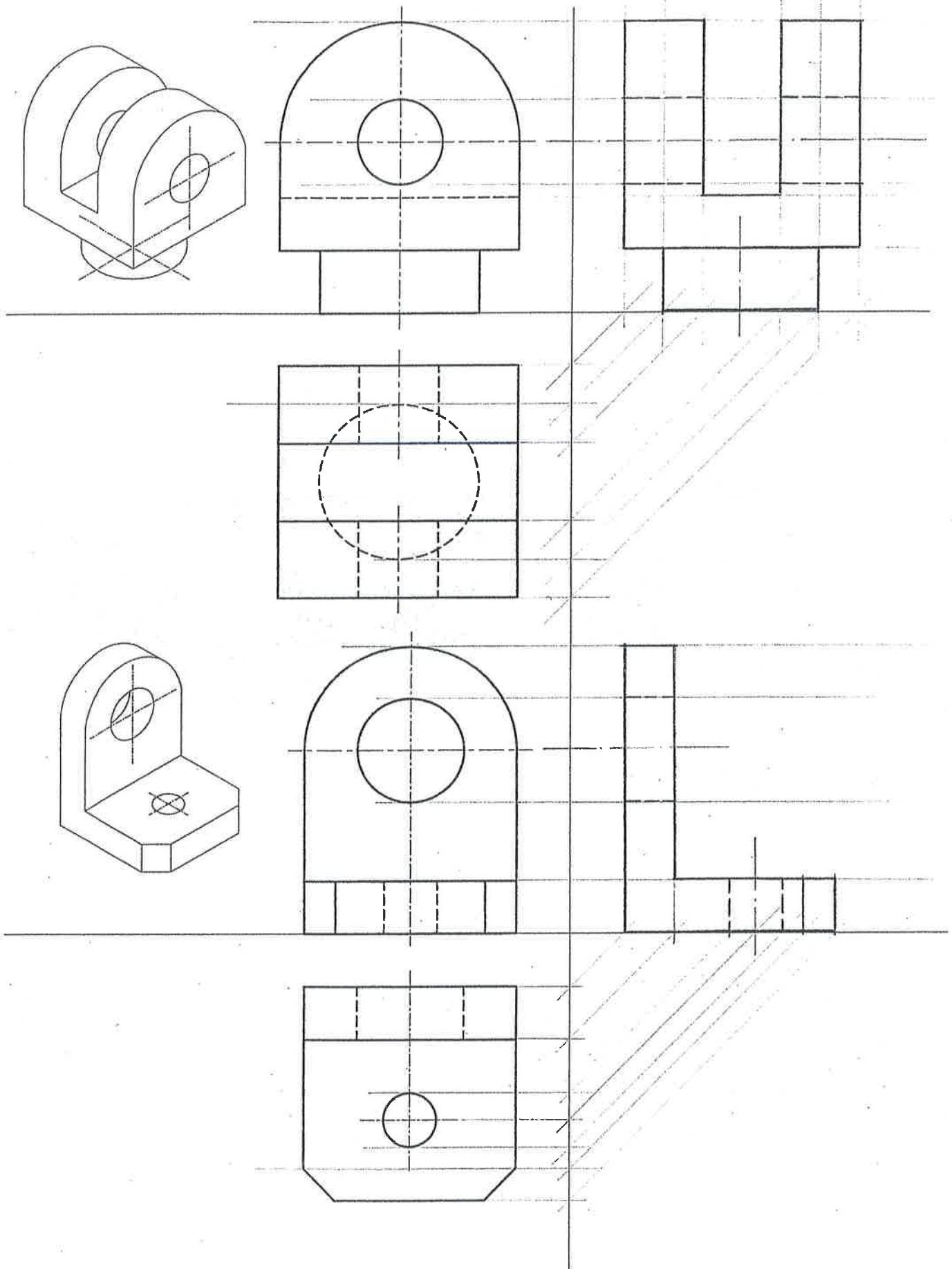

Teiknið þær myndir sem vantar.

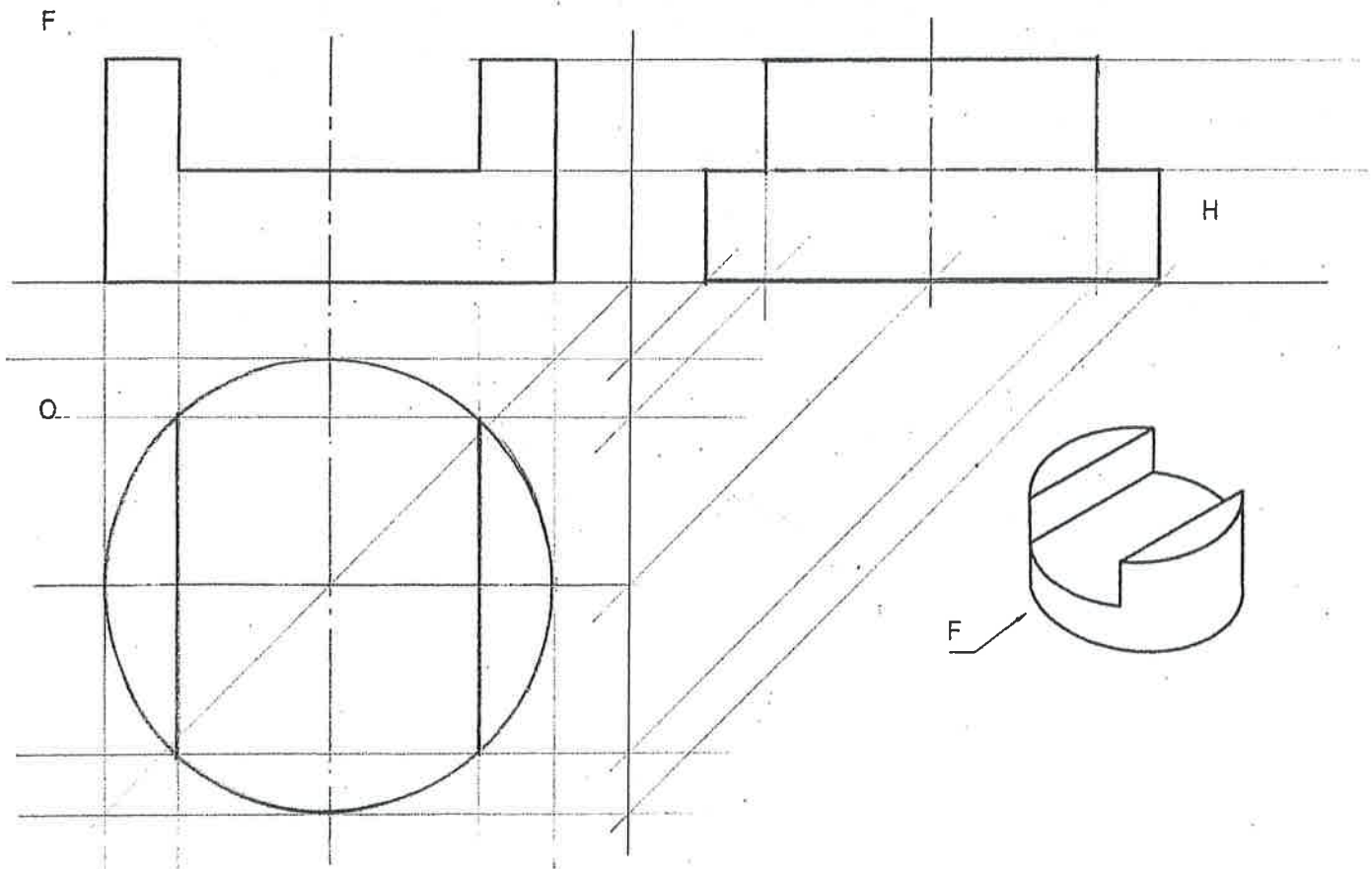
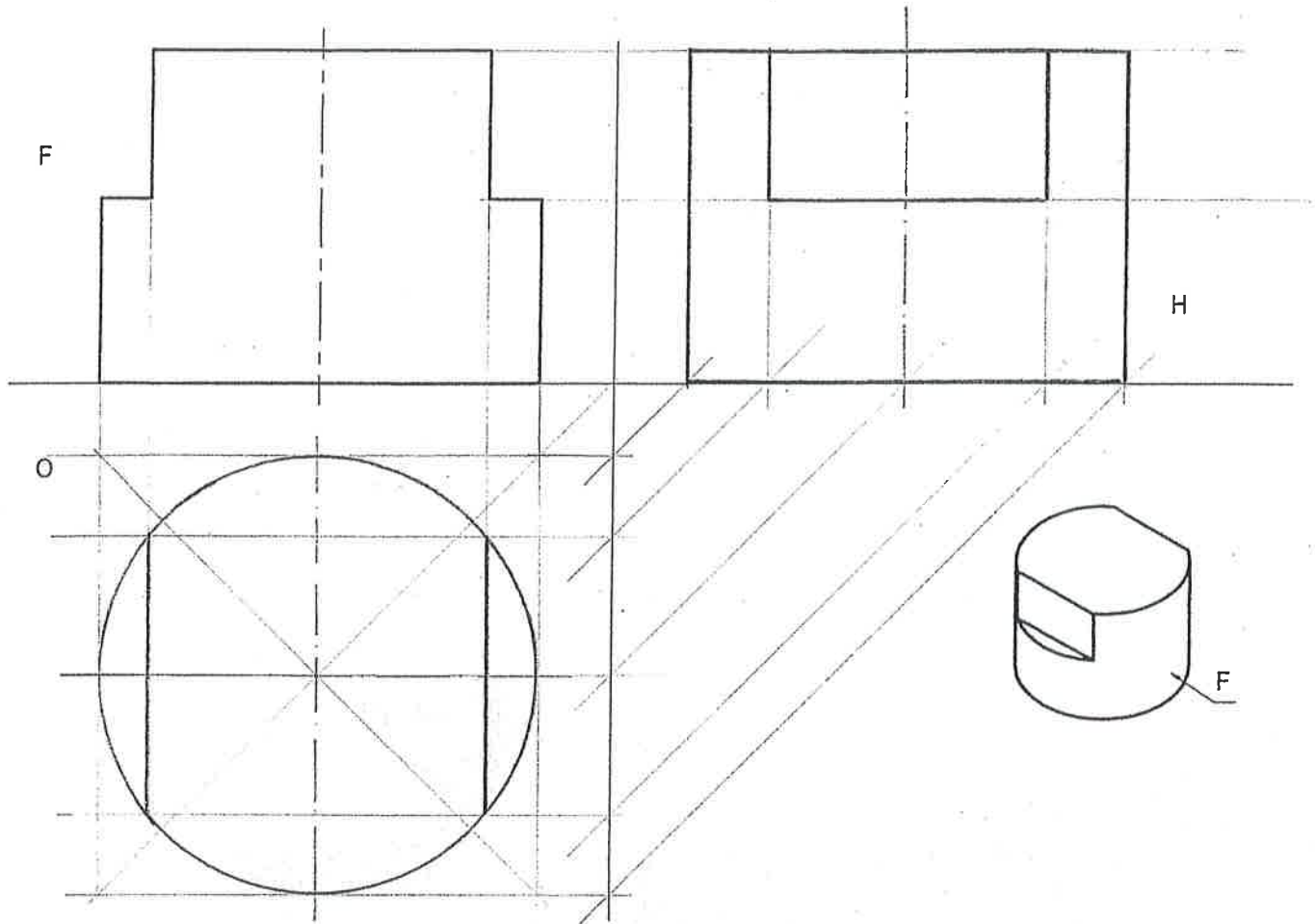

NAFN	AFA	KENNITALA	HÓPUR	DAGS.	2004	YFIRFARID
------	-----	-----------	-------	-------	------	-----------

Séð að framan (frammyndir)

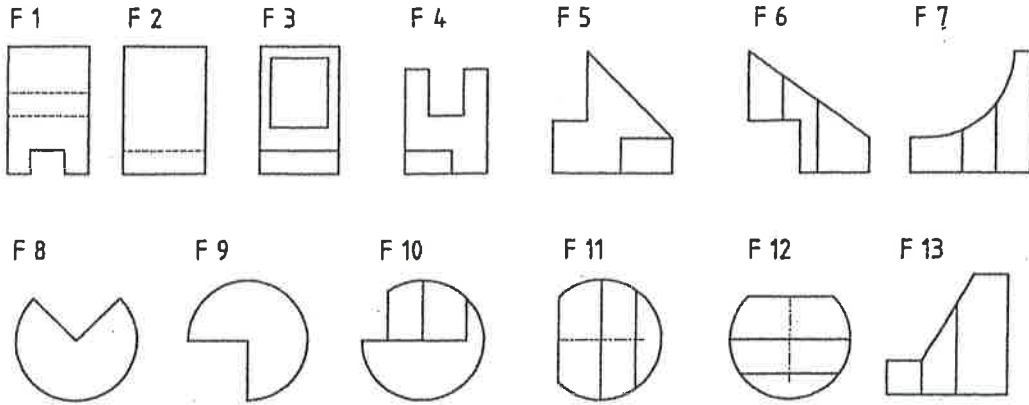

Séð frá hlið (hlöðarmyndir)

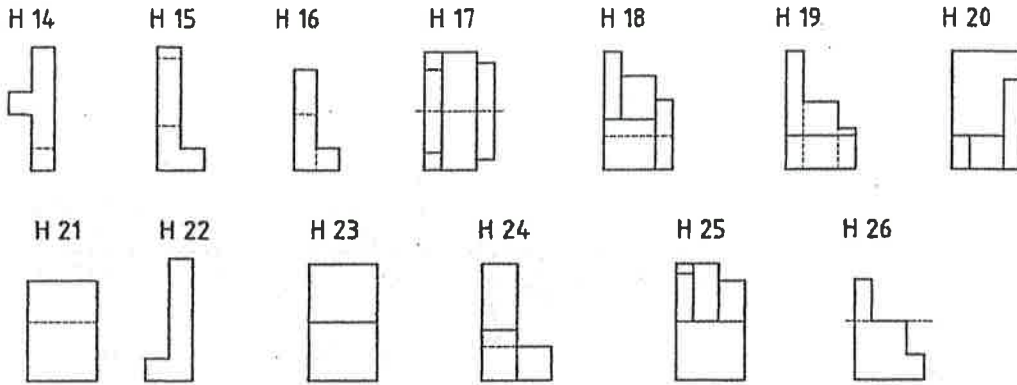

Séð að ofan (ofanmyndir)

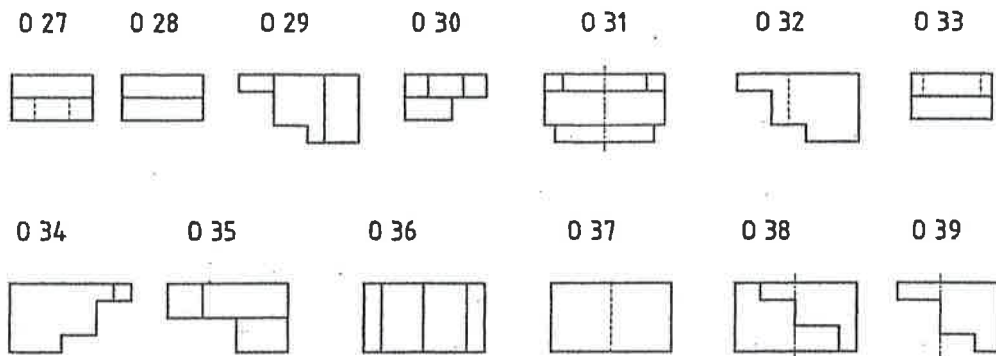









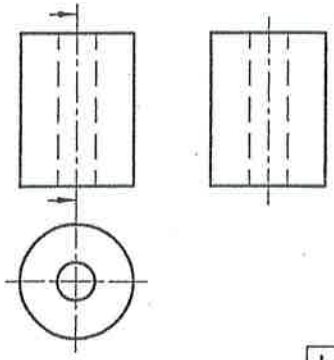
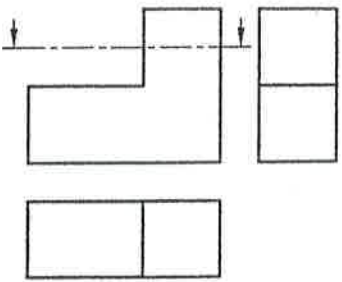

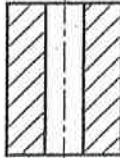
Skrifið í auðu reitina þá tölu fyrir H og O sem passar við hverja lóðréttu mynd F.

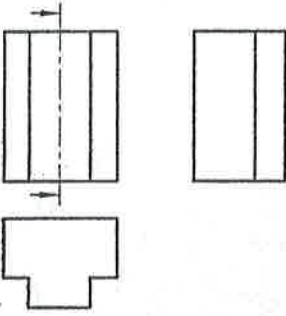
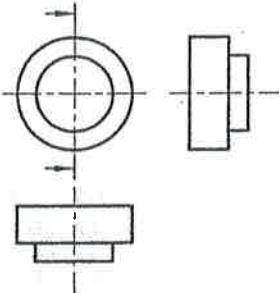
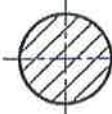

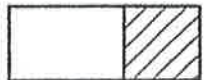
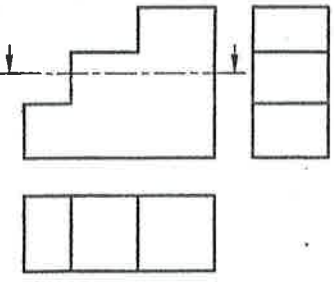
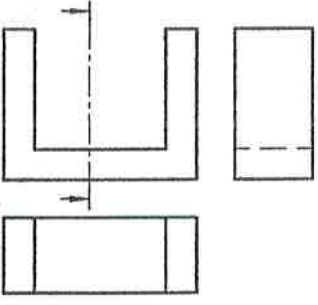
F = Séð að framan	1	2	3	4	5	6	7	8	9	10	11	12	13
H = Séð frá hlið		22							23		17		20
O = Séð að ofan	27		33	30	35			36		38			

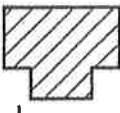
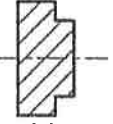
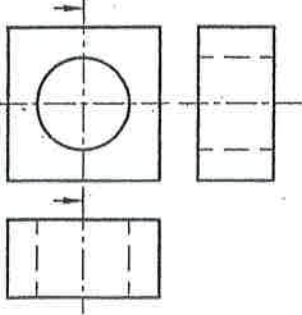
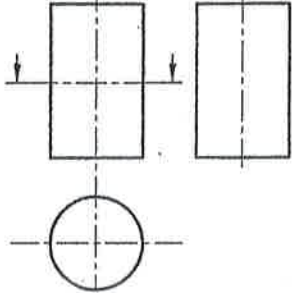
NAFN	AFA	KENNITALA	HÓPUR	DAGS.	2004	YFIRFARIÐ
------	-----	-----------	-------	-------	------	-----------

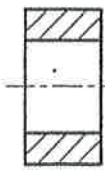
Finnið réttu sneiðmyndina. Búið er að merkja saman H og 1.

 <p style="text-align: right;">H 1</p>	 <p style="text-align: right;">D 2</p>	 <p>F</p>  <p>H</p>  <p>P</p>
 <p style="text-align: right;">A 3</p>	 <p style="text-align: right;">M 4</p>	 <p>C</p>  <p>B</p>  <p>D</p>
 <p style="text-align: right;">F 5</p>	 <p style="text-align: right;">K 6</p>	 <p>A</p>  <p>R</p>  <p>J</p>  <p>M</p>
 <p style="text-align: right;">G 7</p>	 <p style="text-align: right;">C 8</p>	 <p>K</p>  <p>G</p>

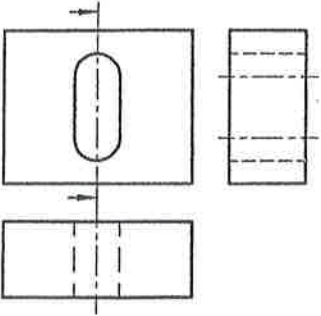
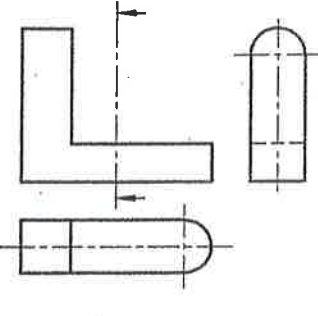
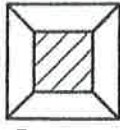
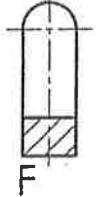
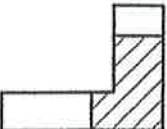
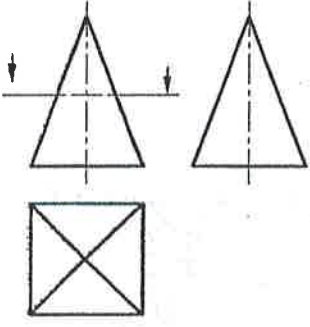
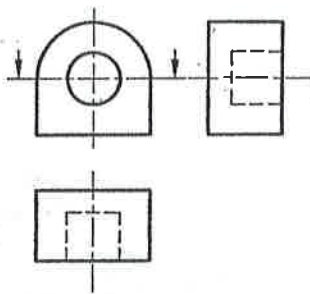
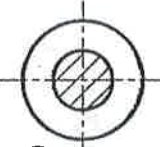
Finnið réttu sneiðmyndina.

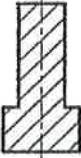
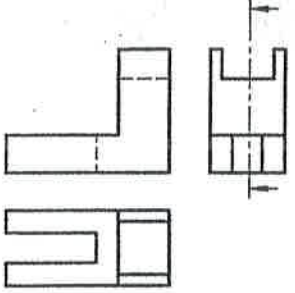
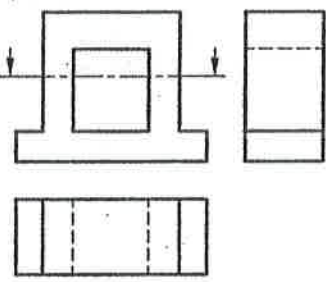
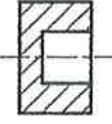
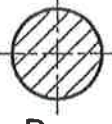
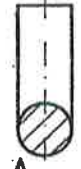
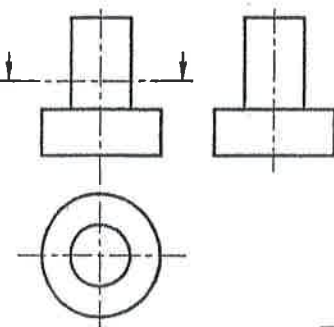
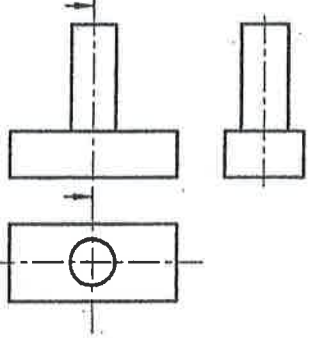
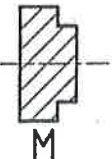
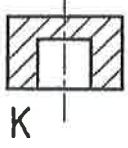
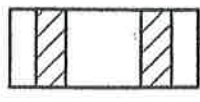
 <p style="text-align: right;">J 1</p>	 <p style="text-align: right;">F 2</p>	 <p style="text-align: center;">C</p>  <p style="text-align: center;">F</p>  <p style="text-align: center;">P</p>
 <p style="text-align: right;">C 3</p>	 <p style="text-align: right;">K 4</p>	 <p style="text-align: center;">B</p>  <p style="text-align: center;">J</p>  <p style="text-align: center;">H</p>
 <p style="text-align: right;">P 5</p>	 <p style="text-align: right;">D 6</p>	 <p style="text-align: center;">L</p>  <p style="text-align: center;">R</p>  <p style="text-align: center;">A</p>
 <p style="text-align: right;">B 7</p>	 <p style="text-align: right;">H 8</p>	 <p style="text-align: center;">M</p>  <p style="text-align: center;">K</p>  <p style="text-align: center;">D</p>

NAFN

AFA

KENNITALA

HÓPUR

DAGS.

2004

YFIRFARIÐ