

Teiknið þær myndir sem vantar og dekkið stytta fleti.

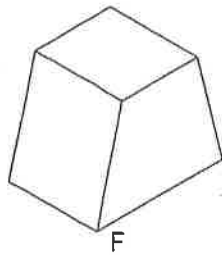

F

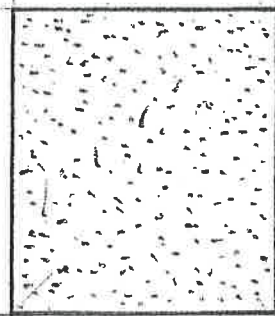
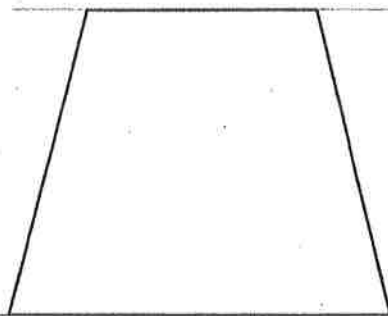

H

O

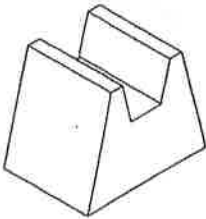
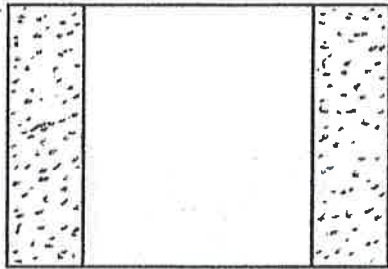

F

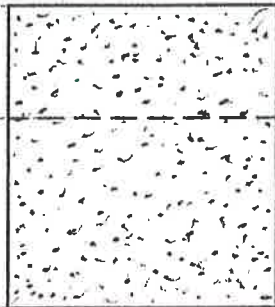
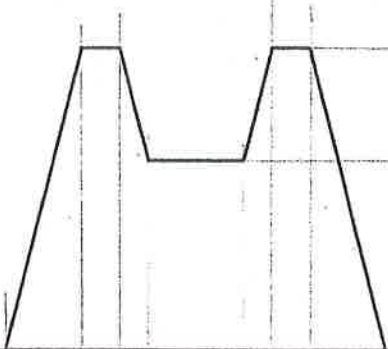

H

O

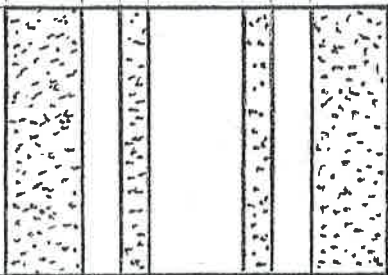

Teiknið þær myndir sem vantar og dekkið stytta fleti.

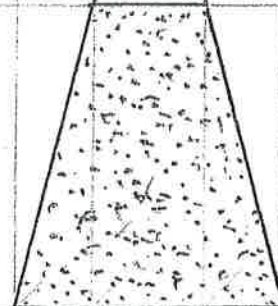
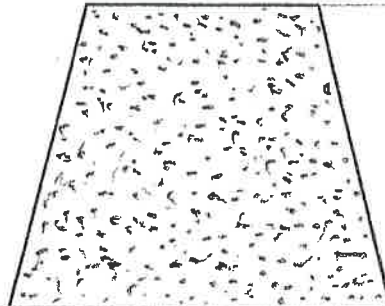
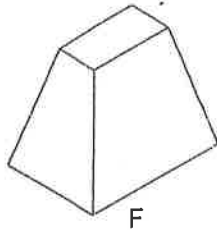

H

O

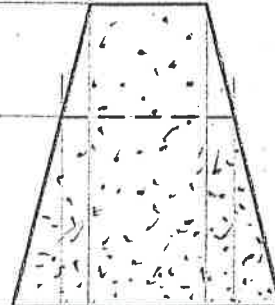
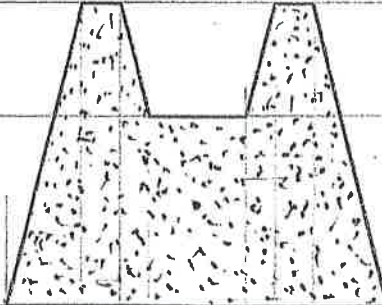
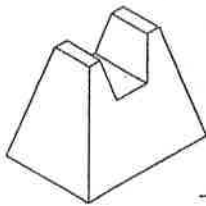
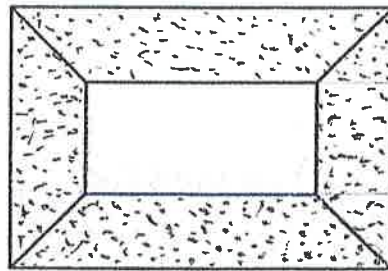

F

H

O

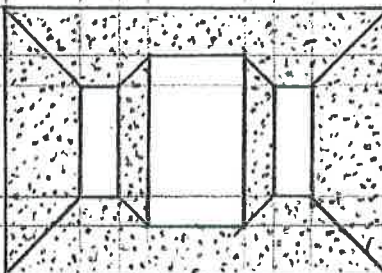

NAFN

AFA

KENNITALA

HÓPUR

DAGS.

2004

YFIRFARID

Teiknið þær línur sem vantar.

The image contains two sets of architectural drawings. Each set consists of a front view (labeled 'F'), a side view (labeled 'H'), and an isometric view (labeled 'F'). The drawings are on a grid with construction lines. The first set (top) shows a house with a gabled roof and a chimney. The second set (bottom) shows a house with a gabled roof and a chimney, but with different proportions. The labels 'F' and 'H' indicate front and side views respectively. The isometric views are labeled 'F'.

NAFN

KENNITALA

HÓPUR

DAGS.

YFIRFARIÐ

Teiknið þær myndir sem vantar.

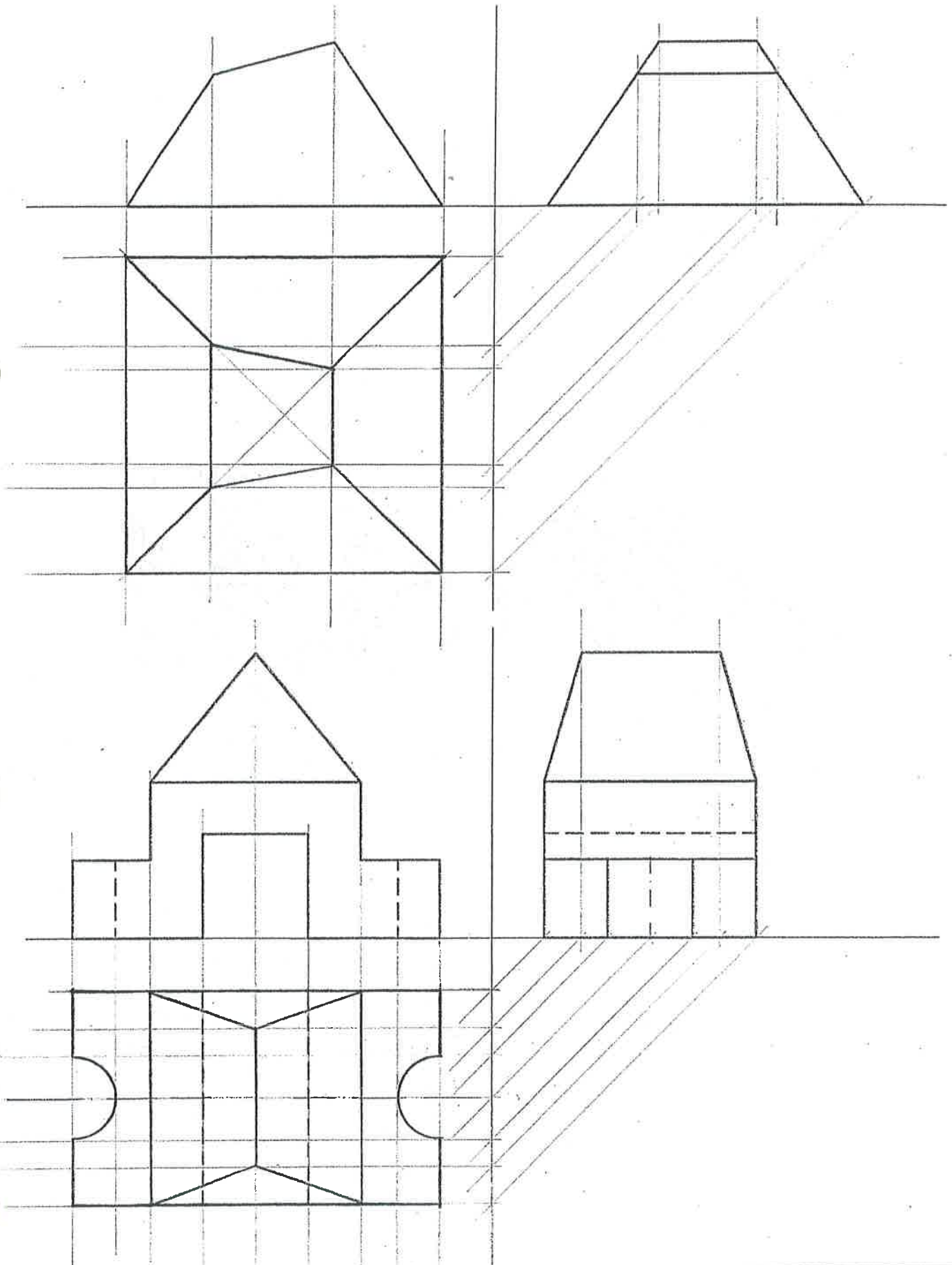

FS-145 Gættarþing - Maí 2003

NAFN

AFA

KENNITALA

HÖPUR

DAGS.

2004

YFIRFARIÐ

Teiknið þær myndir sem vantar.

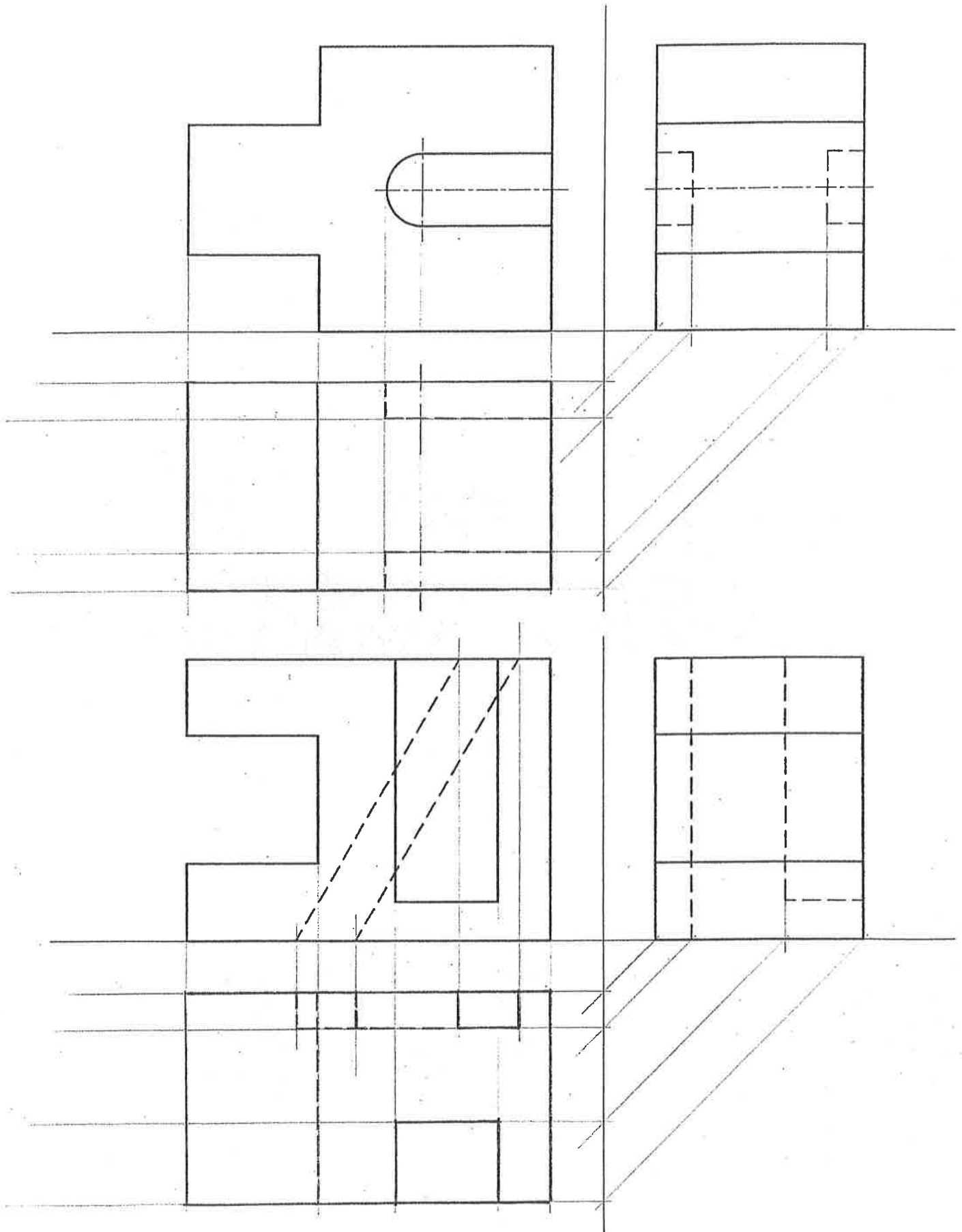

NAFN	<i>AFA</i>	KENNITALA	HÓPUR	DAGS.	<i>2004</i>	YFIRFARID
------	------------	-----------	-------	-------	-------------	-----------

Séð að framan (frammyndir)

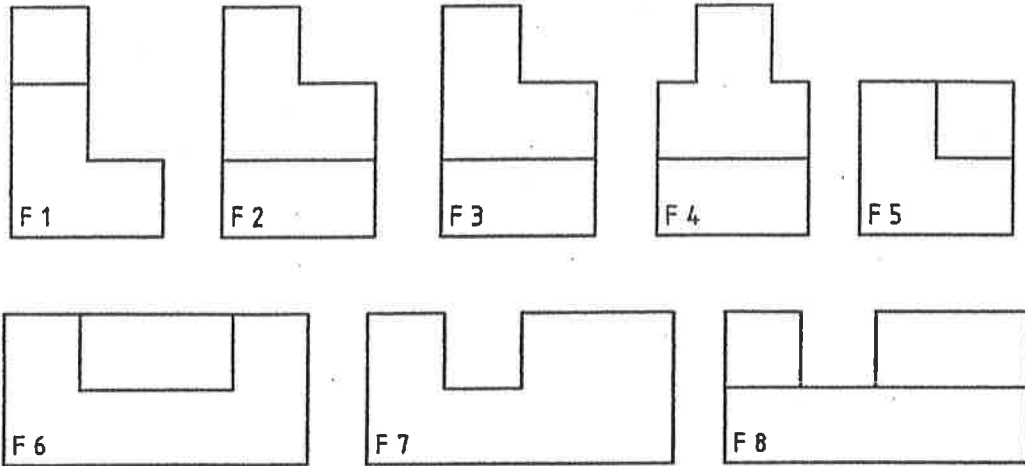

Séð frá hlið (hliðarmyndir)

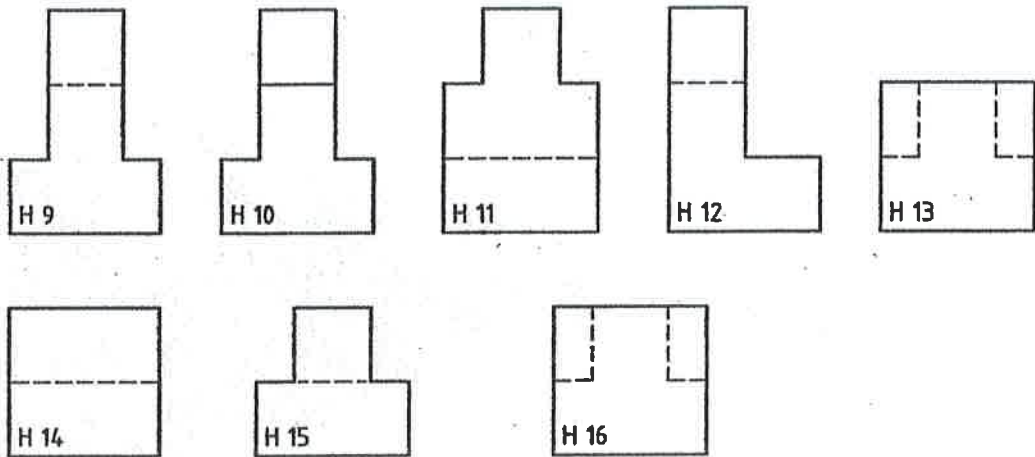

Séð að ofan (ofanmyndir)

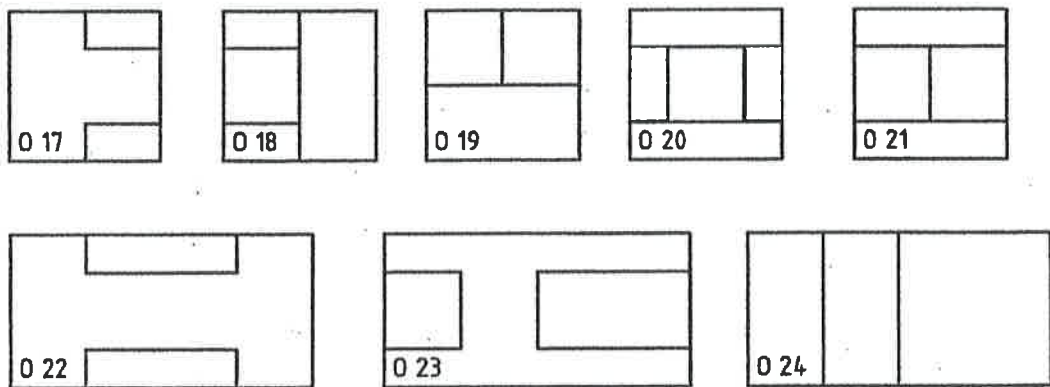

Skrifið í auðu reitina þá tölu fyrir H og O sem passar við hverja lóðrétt mynd F.

F = Séð að framan	1	2	3	4	5	6	7	8
H = Séð frá hlið	11	12	9	10	13/16	13/16	14	15
O = Séð að ofan	18	19	21	20	17	22	24	23

NAFN	AFA	KENNITALA	HÓPUR	DAGS.	2004	YFIRFARIÐ
------	-----	-----------	-------	-------	------	-----------

Teiknið þær myndir sem vantar. Teiknið miðuása með strikpunktalínum.

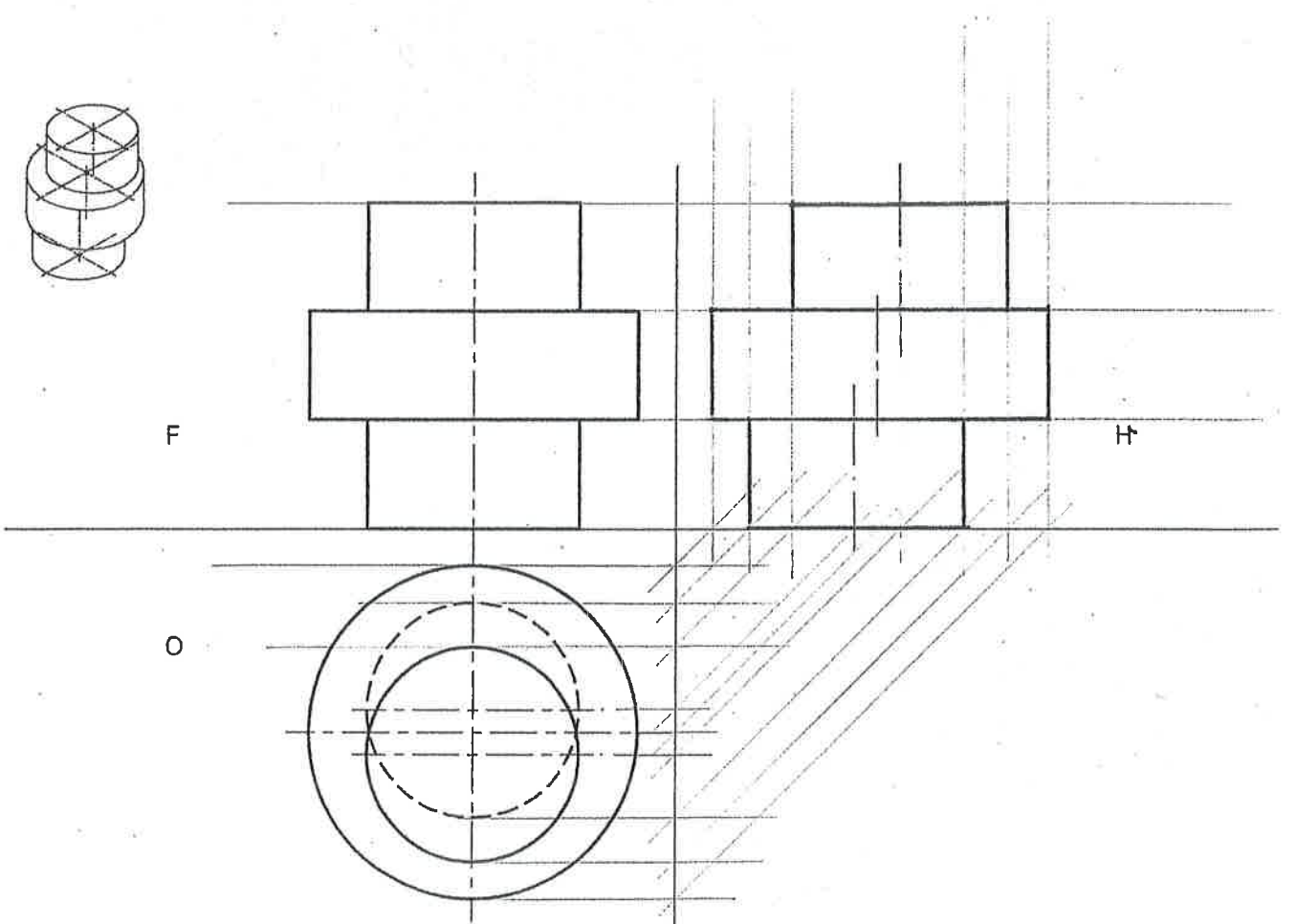
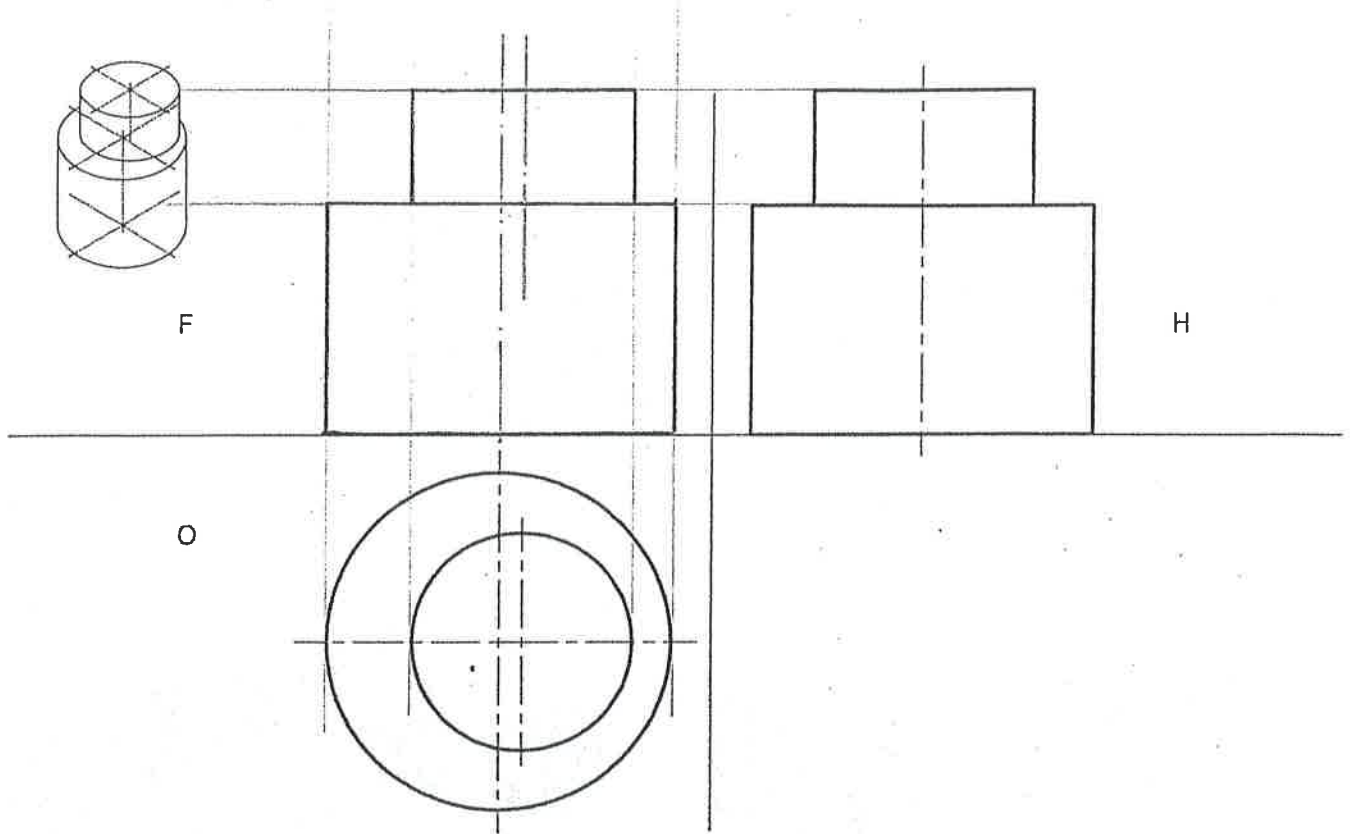

Teiknið þær myndir sem vantar. Teiknið miðjuása með stríkpunktalínum.

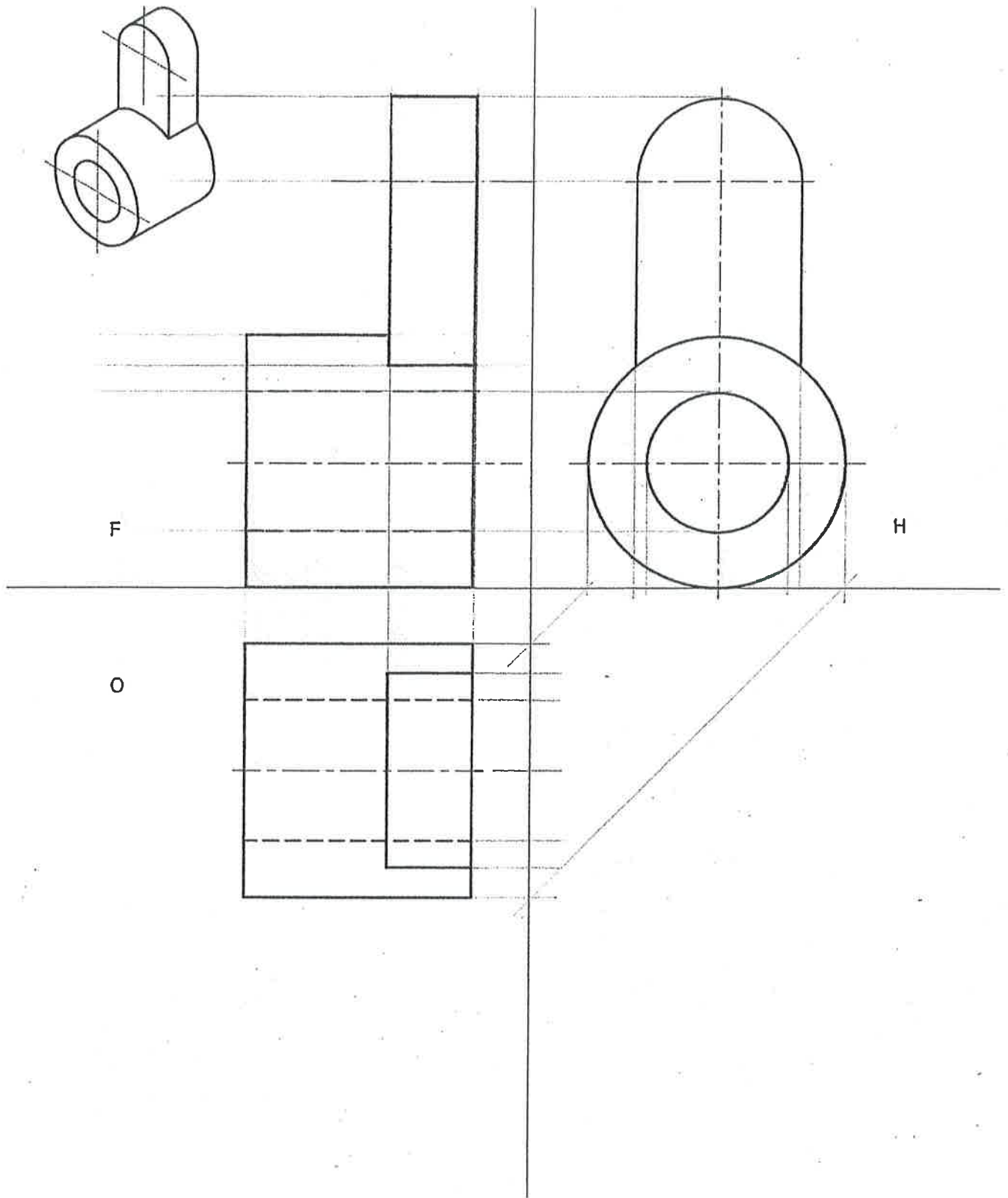

NAFN	AFA	KENNITALA	HÓPUR	DAGS.	2004	YFIRFARIÐ
------	-----	-----------	-------	-------	------	-----------

Teiknið þær myndir sem vantar.

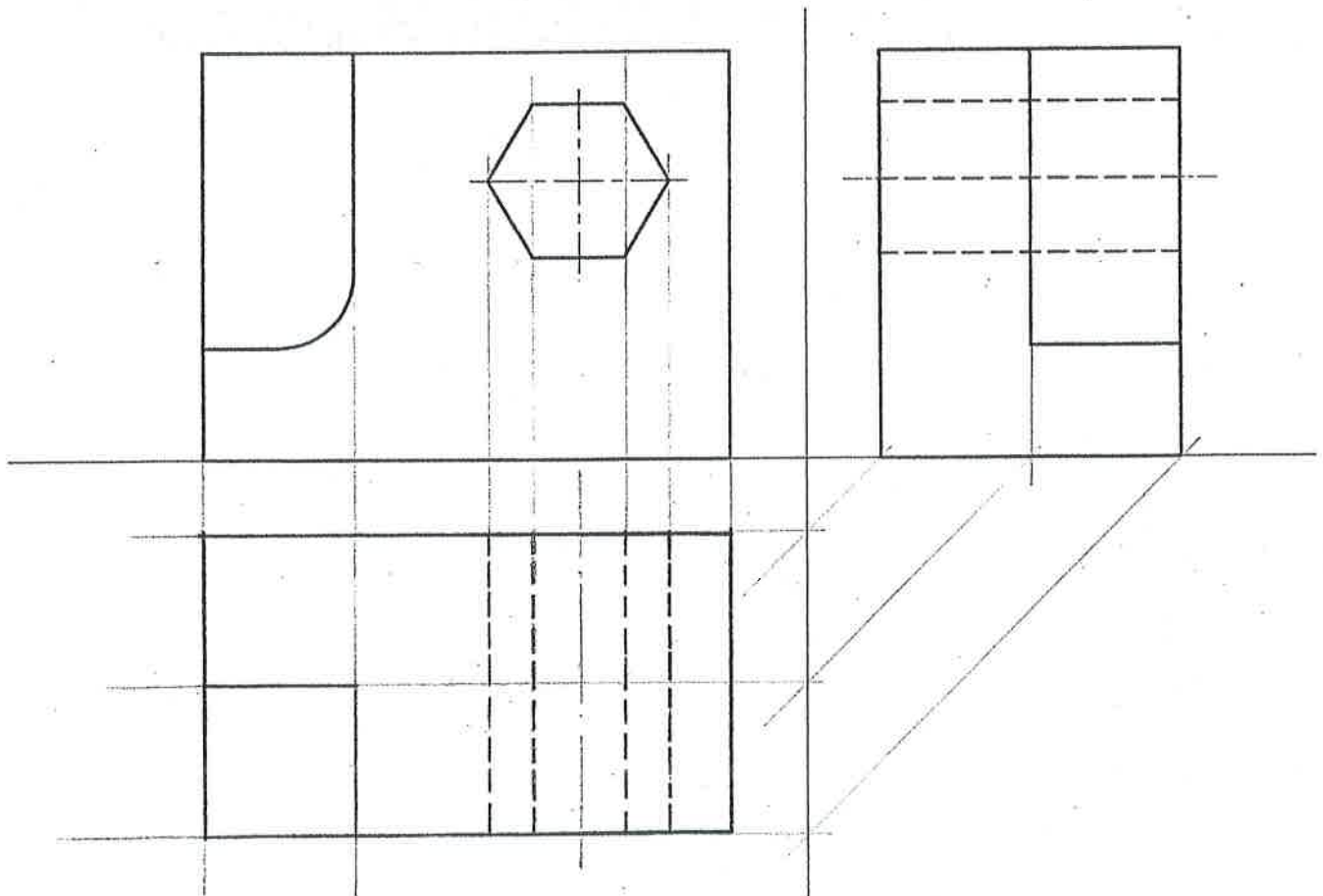
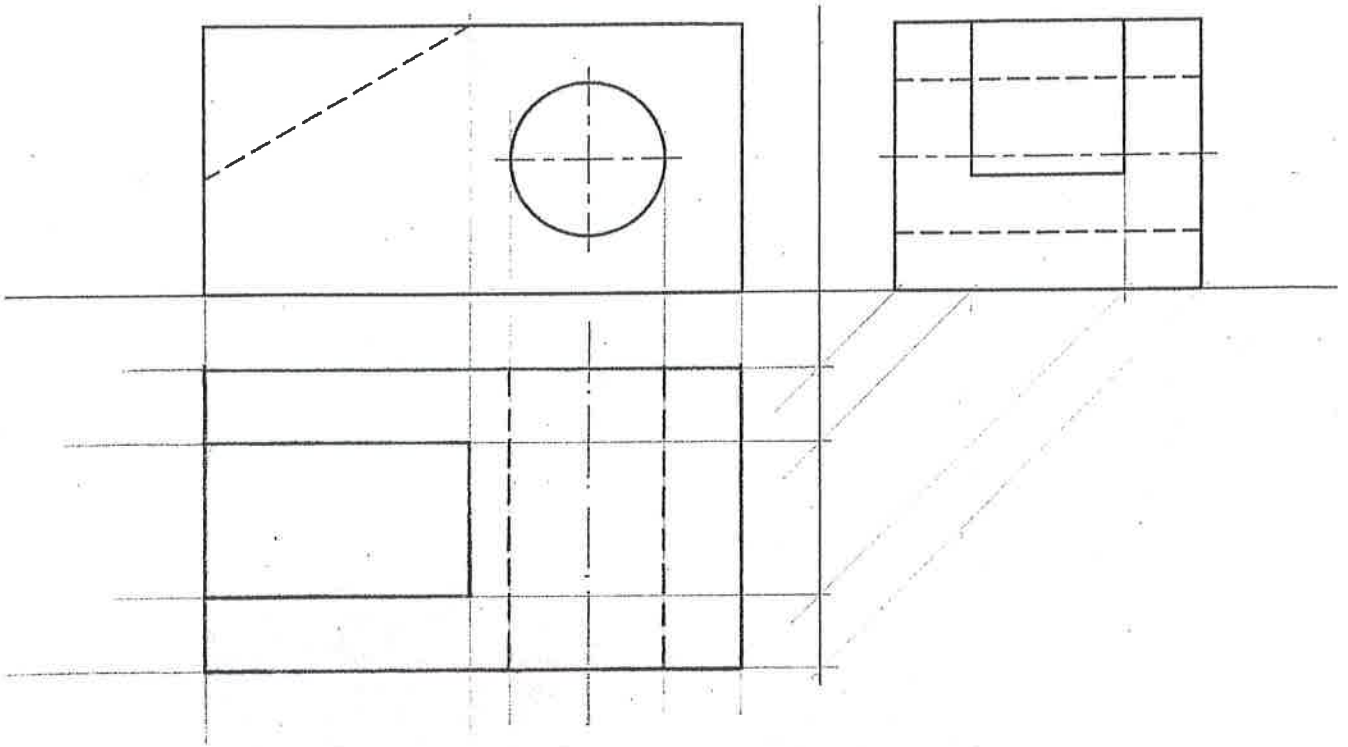

NAFN

AFA

KENNITALA

HÓPUR

DAGS.

2004

YFIRFARIÐ

Teiknið þær myndir sem vantar.

a.m.k. 3 valkostir

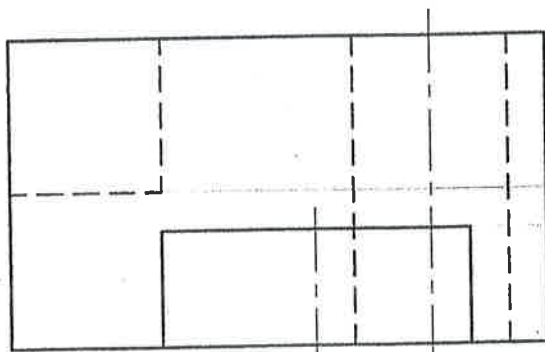
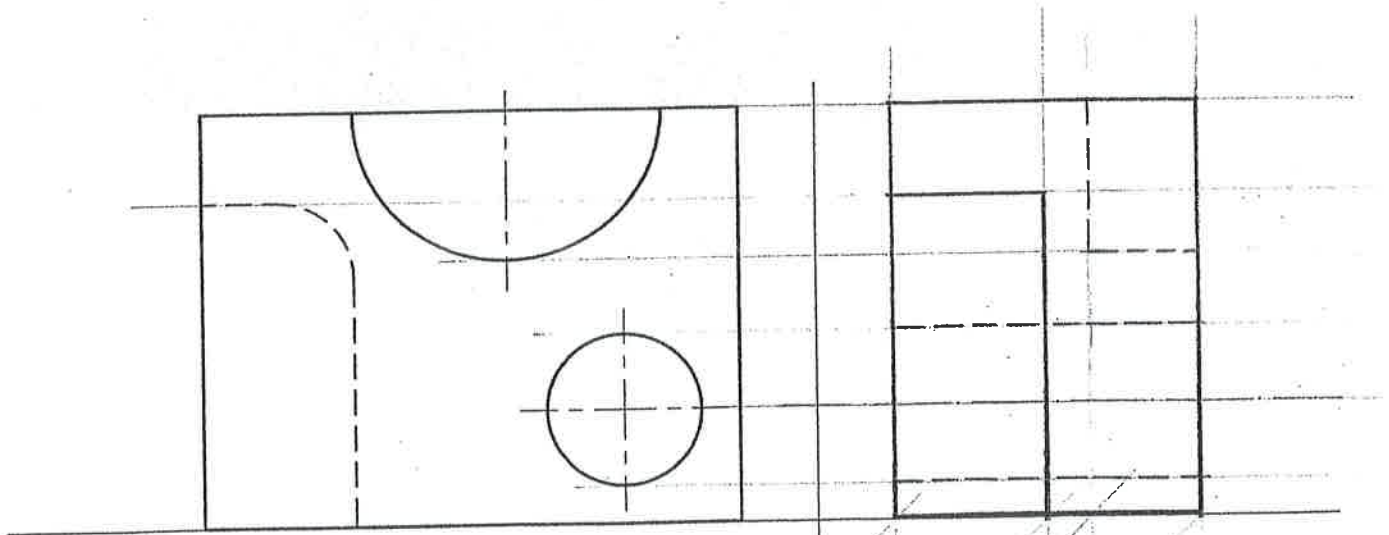
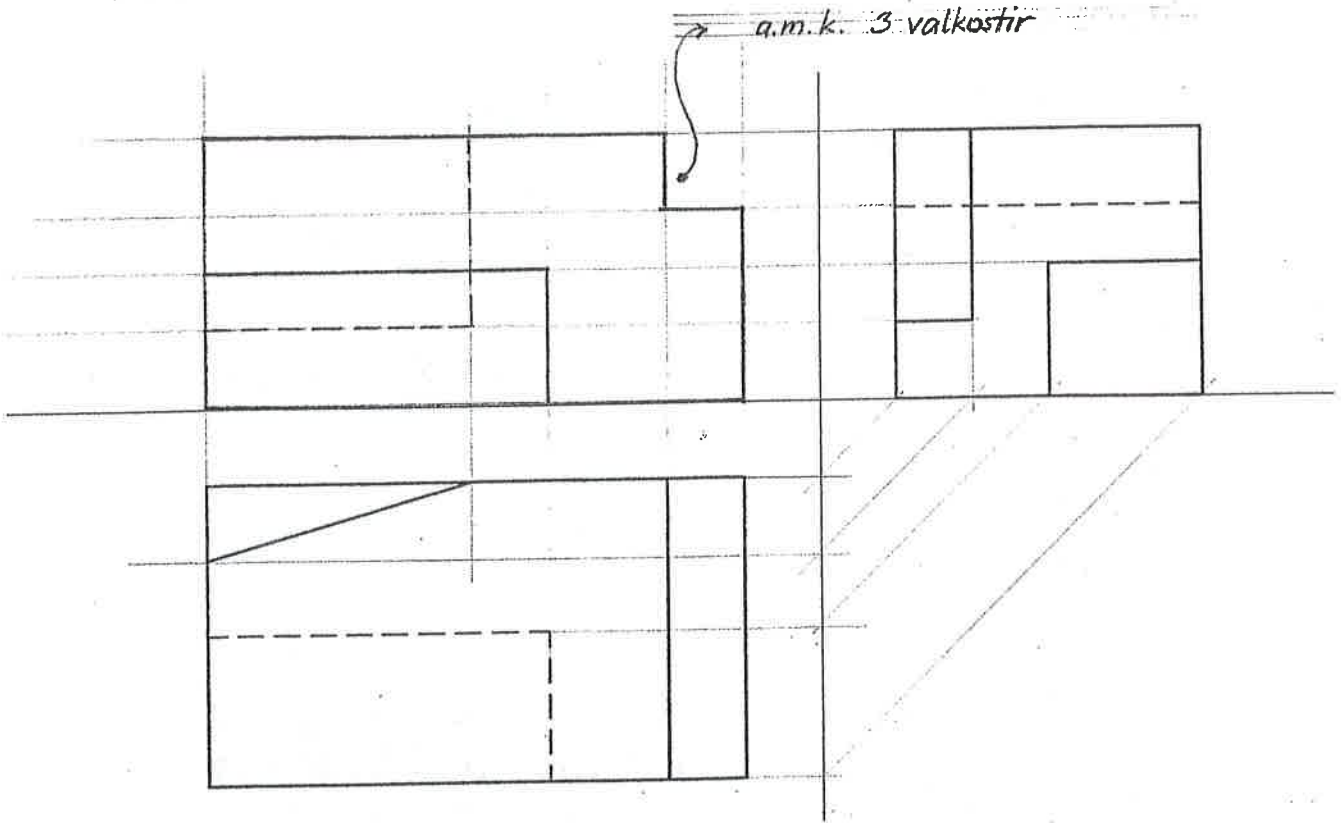

NAFN	AFA	KENNITALA	HÓPUR	DAGS.	2004	YFIRFARIÐ
------	-----	-----------	-------	-------	------	-----------

Teiknið þær myndir sem vantar.

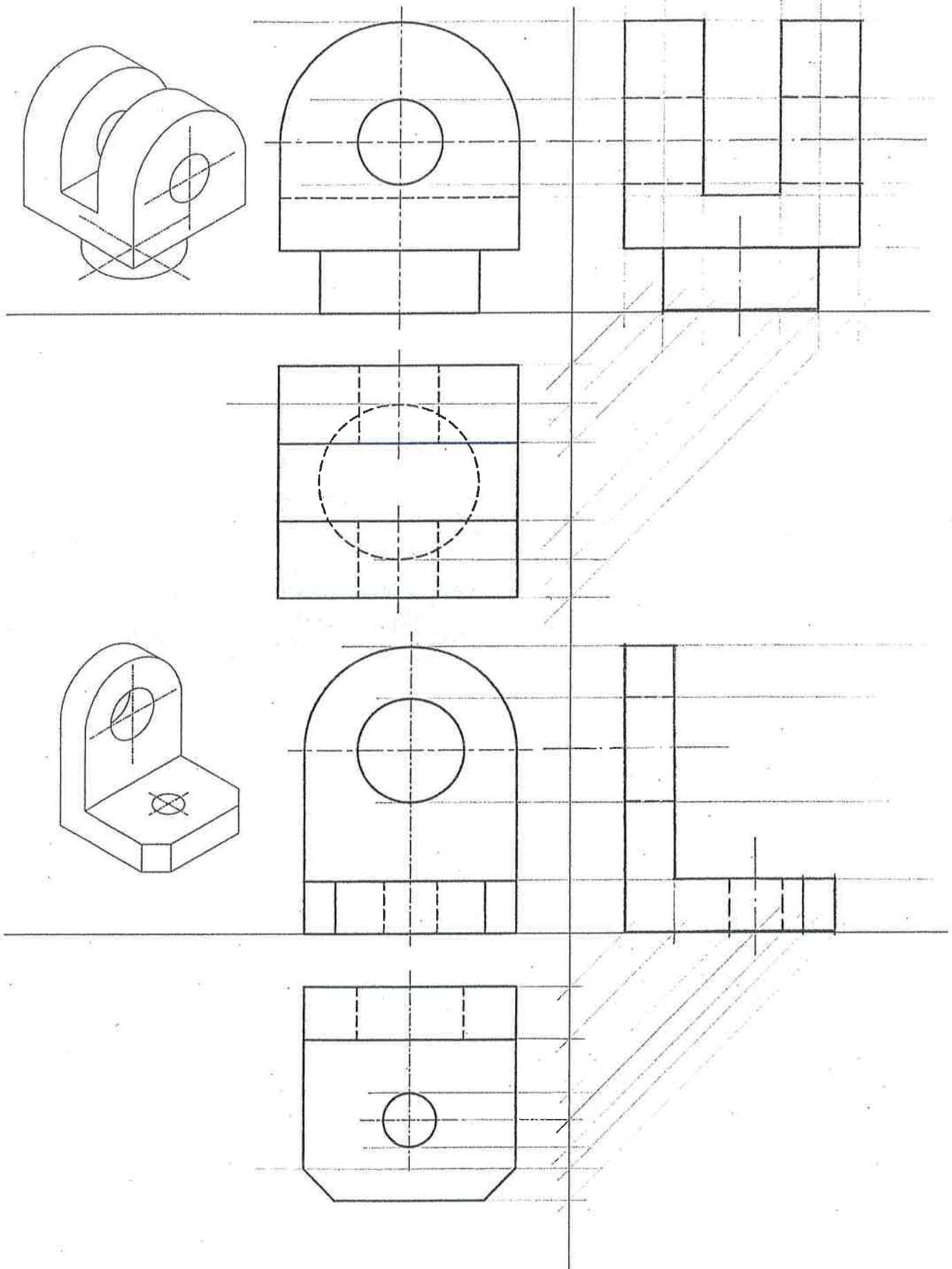

Teiknið þær myndir sem vantar.

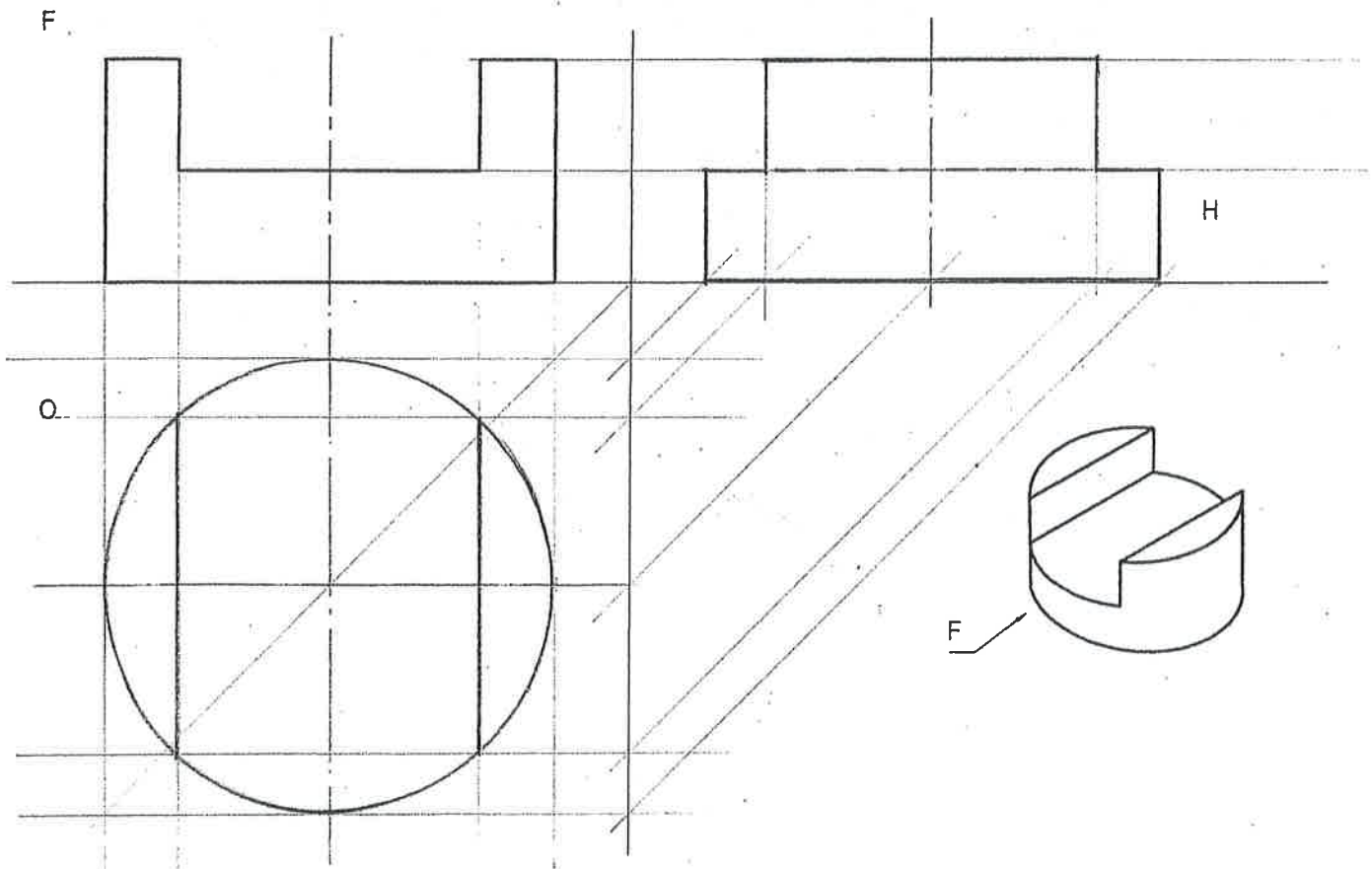
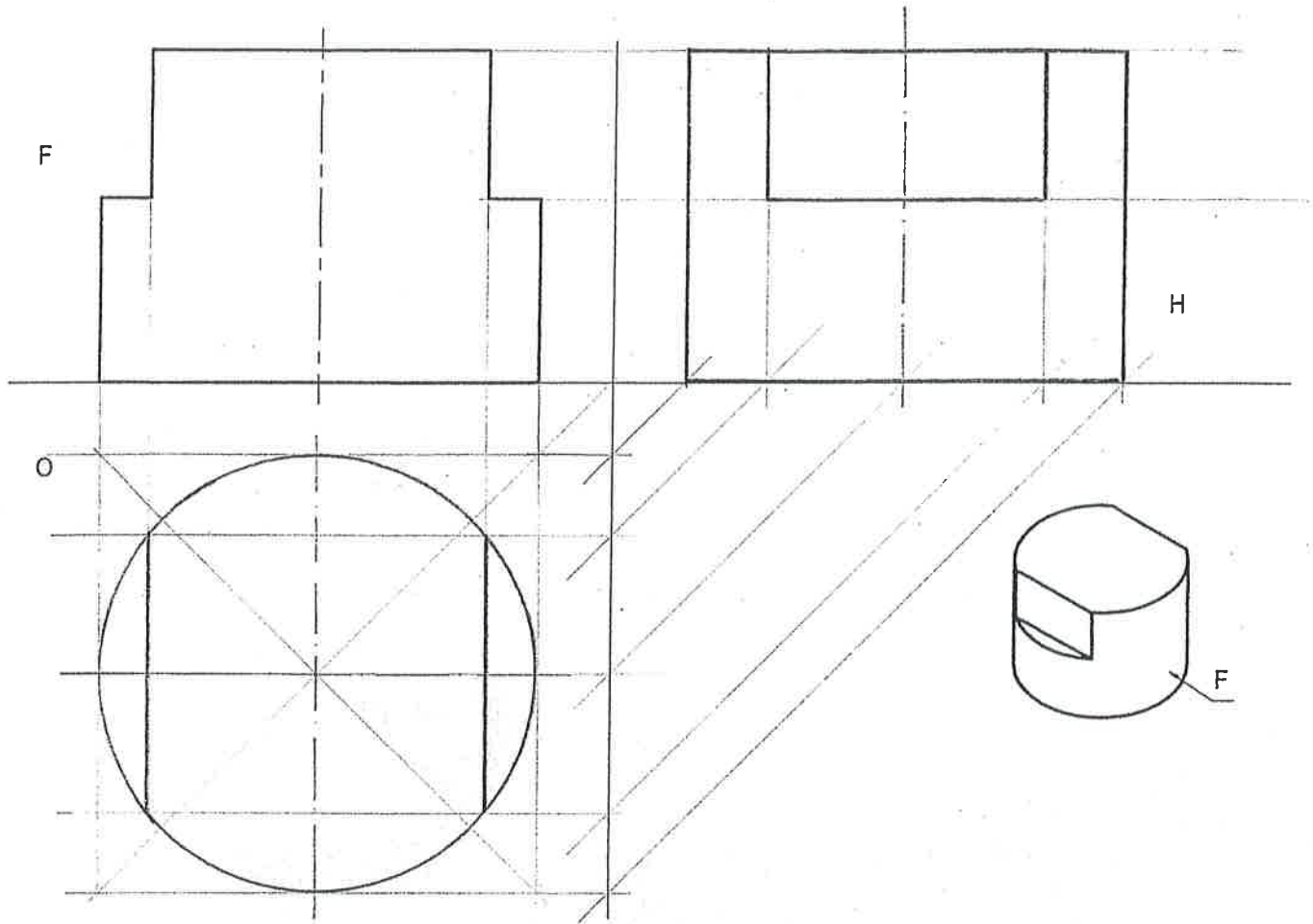

NAFN	AFA	KENNITALA	HÓPUR	DAGS.	2004	YFIRFARID
------	-----	-----------	-------	-------	------	-----------

Séð að framan (frammyndir)

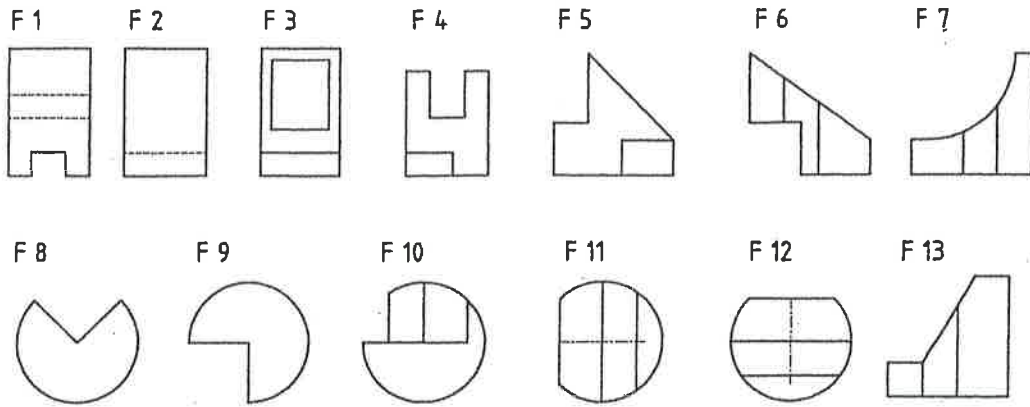

Séð frá hlið (hlíðarmyndir)

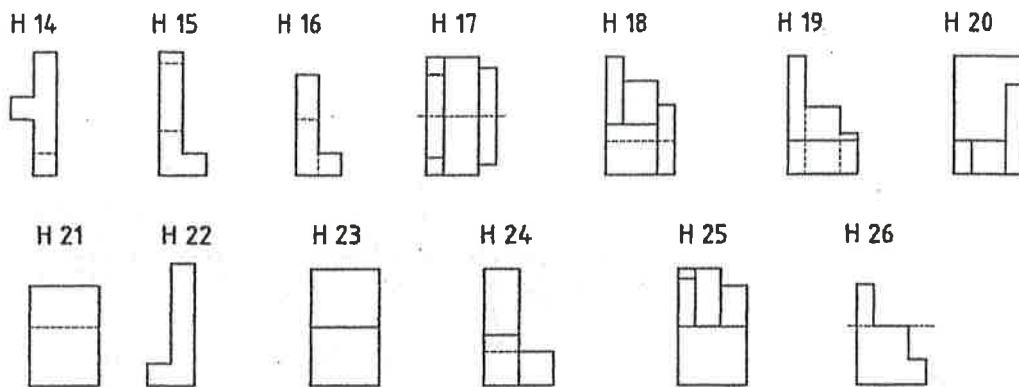

Séð að ofan (ofanmyndir)

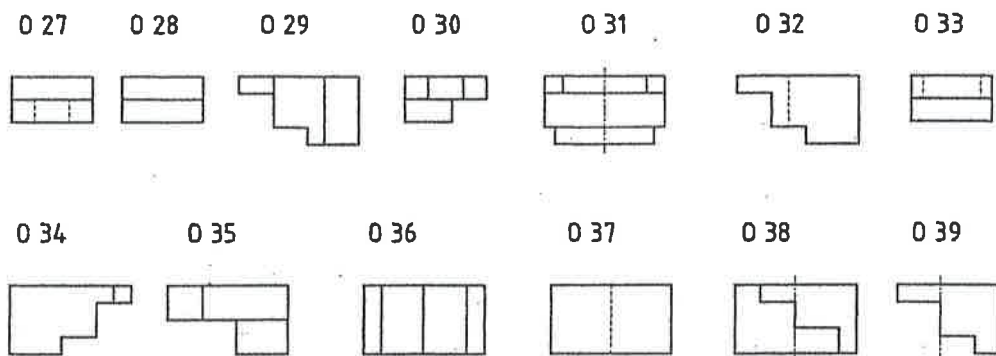







Skrifið í auðu reitina þá tölu fyrir H og O sem passar við hverja lóðréttu mynd F.

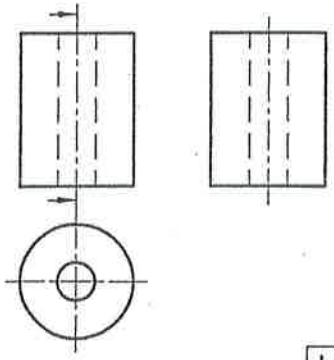
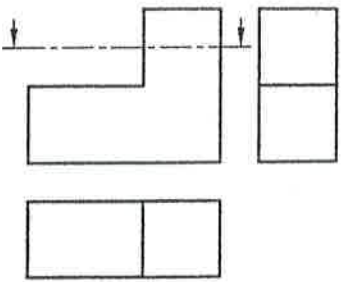

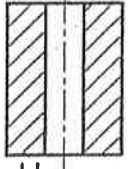
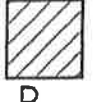
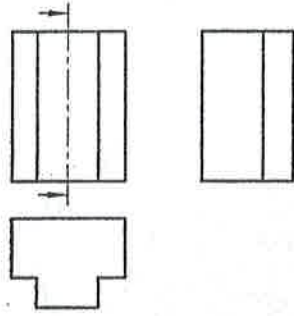
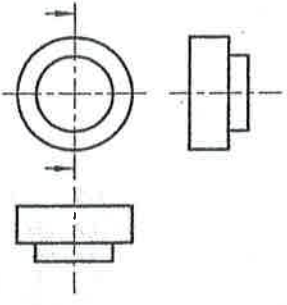
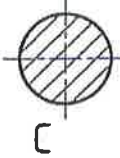
F = Séð að framan	1	2	3	4	5	6	7	8	9	10	11	12	13
H = Séð frá hlið	14	22	15	16	24	18	19	21	23	25	17	26	20
O = Séð að ofan	27	28	33	30	35	32	34	36	37	38	39	31	29

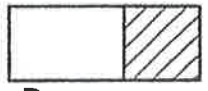
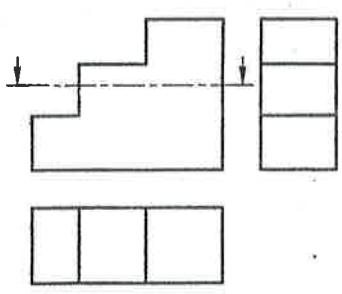
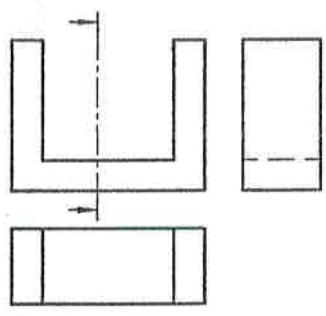
NAFN	AFA	KENNITALA	HÓPUR	DAGS.	2004	YFIRFARIÐ
------	-----	-----------	-------	-------	------	-----------

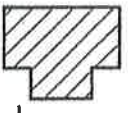
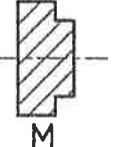
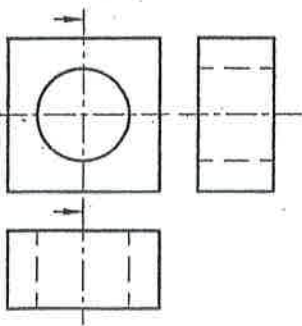
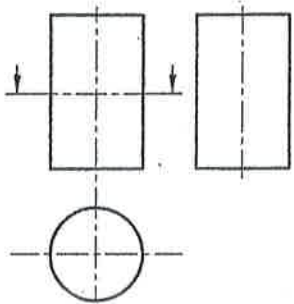
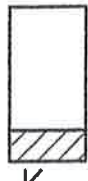
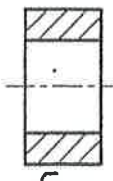
Finnið réttu sneiðmyndina. Búið er að merkja saman H og 1.

 <p>H 1</p>	 <p>D 2</p>	 <p>F</p>  <p>H</p>  <p>P</p>
 <p>A 3</p>	 <p>M 4</p>	 <p>C</p>  <p>B</p>  <p>D</p>
 <p>F 5</p>	 <p>K 6</p>	 <p>A</p>  <p>R</p>  <p>J</p>  <p>M</p>
 <p>G 7</p>	 <p>C 8</p>	 <p>K</p>  <p>G</p>

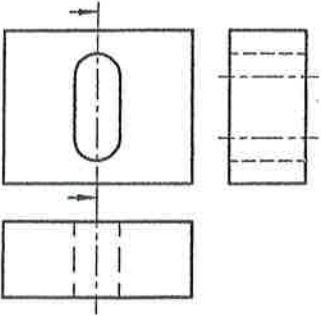
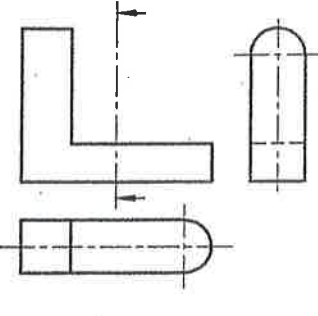
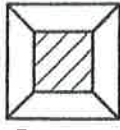
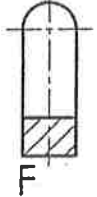
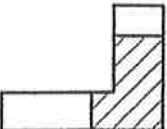
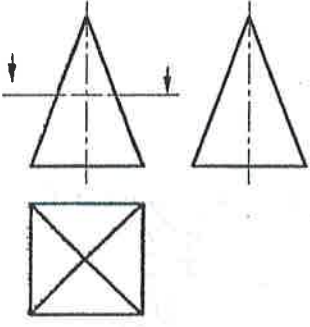
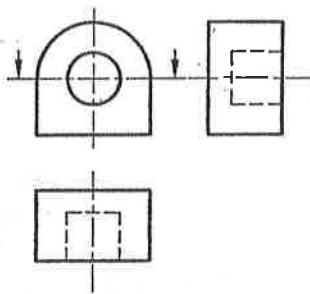
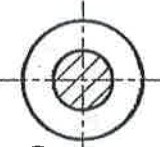
Finnið réttu sneiðmyndina.

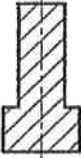
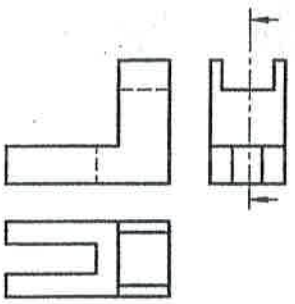
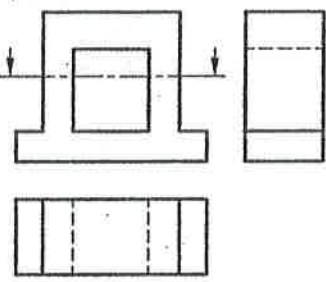
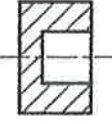
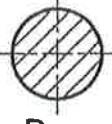
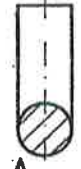
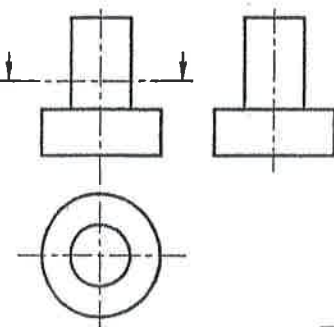
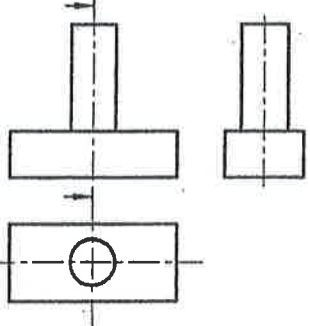
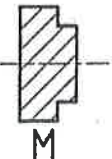
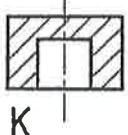
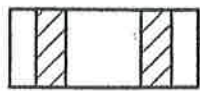
 <p style="text-align: right;">J 1</p>	 <p style="text-align: right;">F 2</p>	 <p style="text-align: center;">C</p>  <p style="text-align: center;">F</p>  <p style="text-align: center;">P</p>
 <p style="text-align: right;">C 3</p>	 <p style="text-align: right;">K 4</p>	 <p style="text-align: center;">B</p>  <p style="text-align: center;">J</p>  <p style="text-align: center;">H</p>
 <p style="text-align: right;">P 5</p>	 <p style="text-align: right;">D 6</p>	 <p style="text-align: center;">L</p>  <p style="text-align: center;">R</p>  <p style="text-align: center;">A</p>
 <p style="text-align: right;">B 7</p>	 <p style="text-align: right;">H 8</p>	 <p style="text-align: center;">M</p>  <p style="text-align: center;">K</p>  <p style="text-align: center;">D</p>